



See More

See Clarity

**DENTRI α**

HDX WILL

# HDX CYOPTIX

Our **ongoing** software technology development creates striking contrast and sharpness of images. We strive to provide you with the latest technology.

Explore the transition with CYOPTIX

Enhanced Recon Algorithm Applied

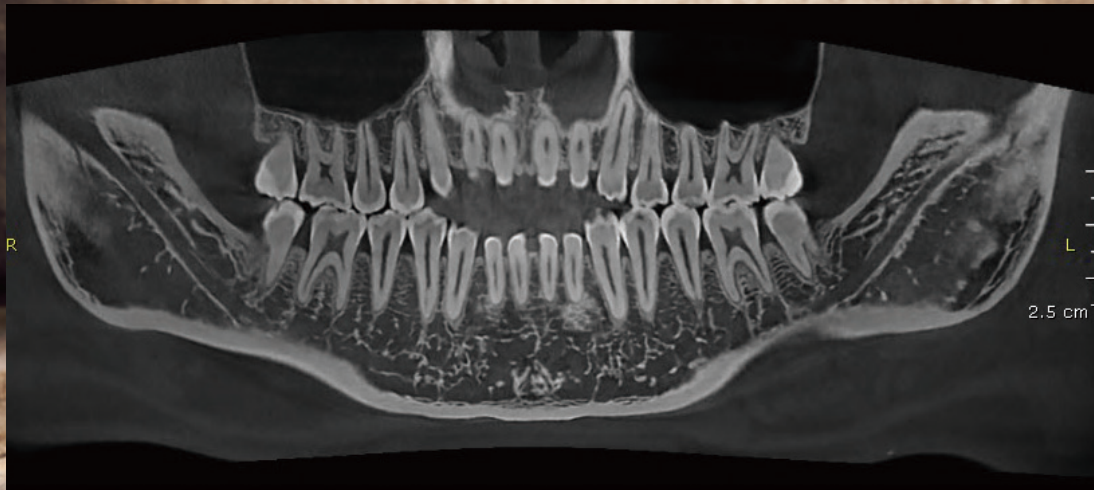

# Dentri $\alpha$ <sup>TM</sup> Classic

Renowned for its Crisp, Ultra-HD imagery, Dentri  $\alpha$  Classic will become an indispensable part of your expanding practice. Powerful yet flexible, the Dentri  $\alpha$  Classic provides a wide **Field of View (FOV) 16 x 8cm** and crisp panoramic imaging.



# Dentri $\alpha$ <sup>TM</sup> Extended

The Dentri  $\alpha$  Extended CBCT expands the **Field of View (FOV) 16 x 14.5cm**. Extended allows for an expanded view of facial structures, sinus, TMJ, and dentition with the quality images Dentri  $\alpha$  provides.

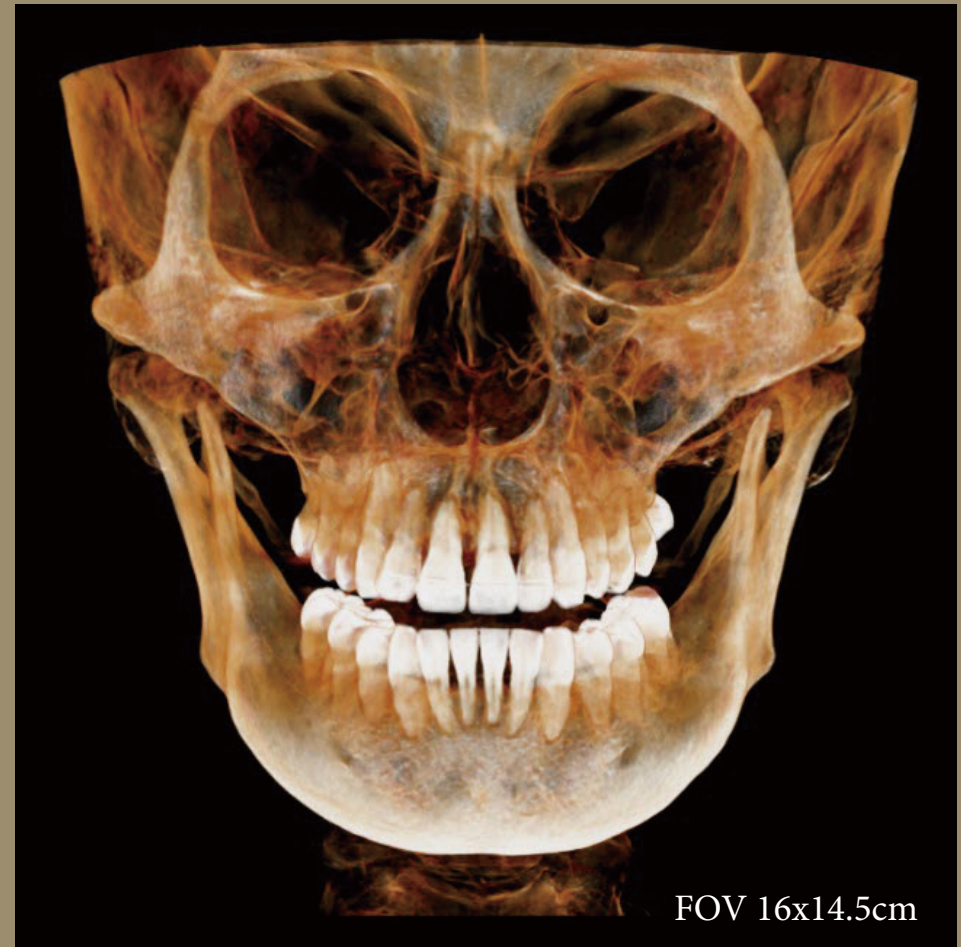

# Free Field of View

Capture **ANY SIZE** for diagnosis



Implant evaluation



Buccal View In-Occlusion

# Voxel Size

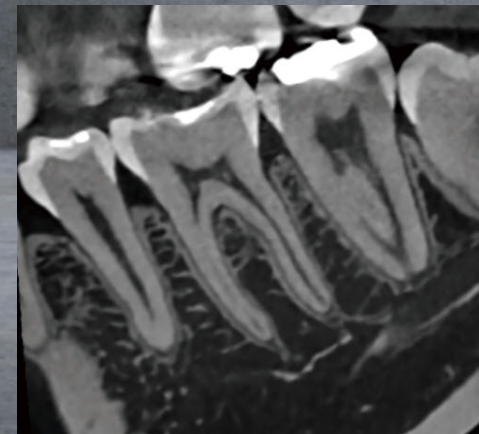

Precise Diagnosis  
**Min 0.1mm** voxel size

# Ultra Fast Scan



Normal Scan

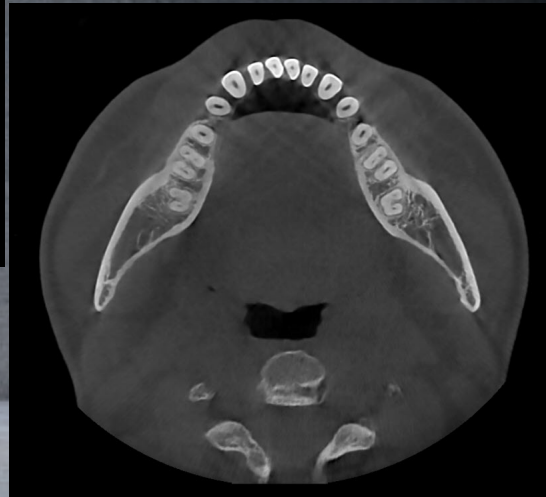

Ultra Fast Scan

Ultra Fast Scan- Reduces motion artifacts and lowers radiation dose

# Metal Artifact Reduction

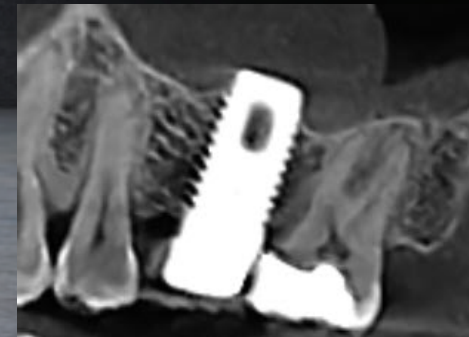
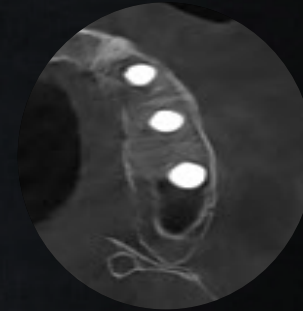

MAR- Reduces metal artifacts for diagnosis

# PrecisionMAR™ (Optional)

Our newest algorithm offers unprecedented clarity around metal, improving diagnostics and planning.

MAR

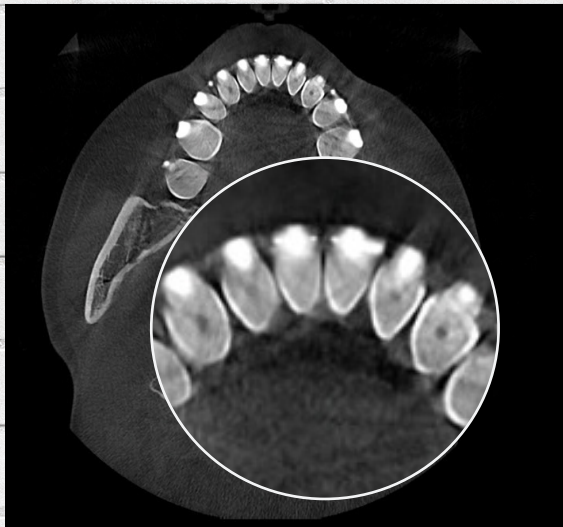

PrecisionMAR™

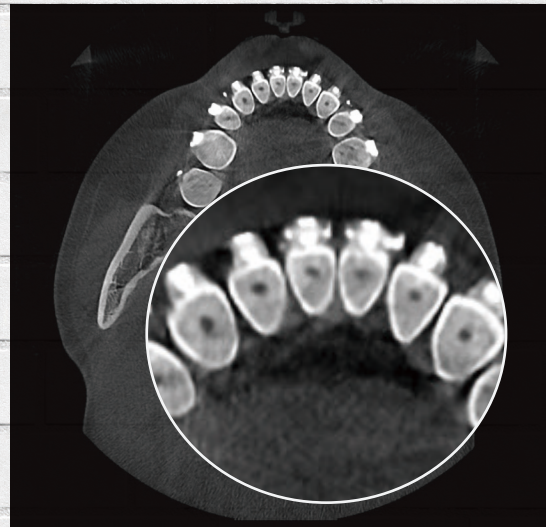

- Minimal scatter
- Reduced shading
- Clearly define bone and teeth structures around metal

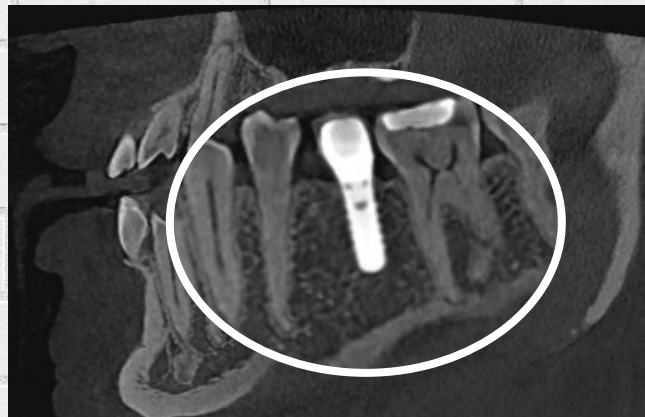
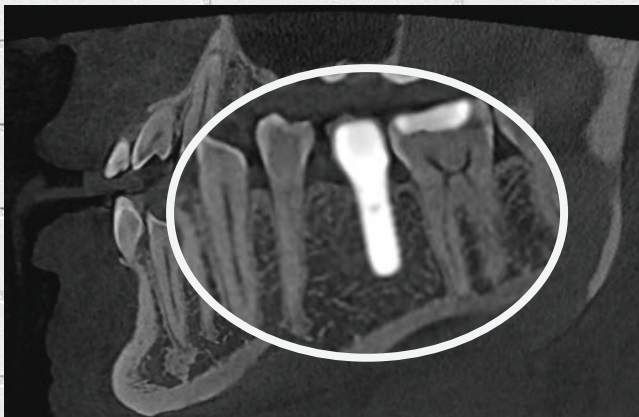

# Digital Implant Treatment Planning

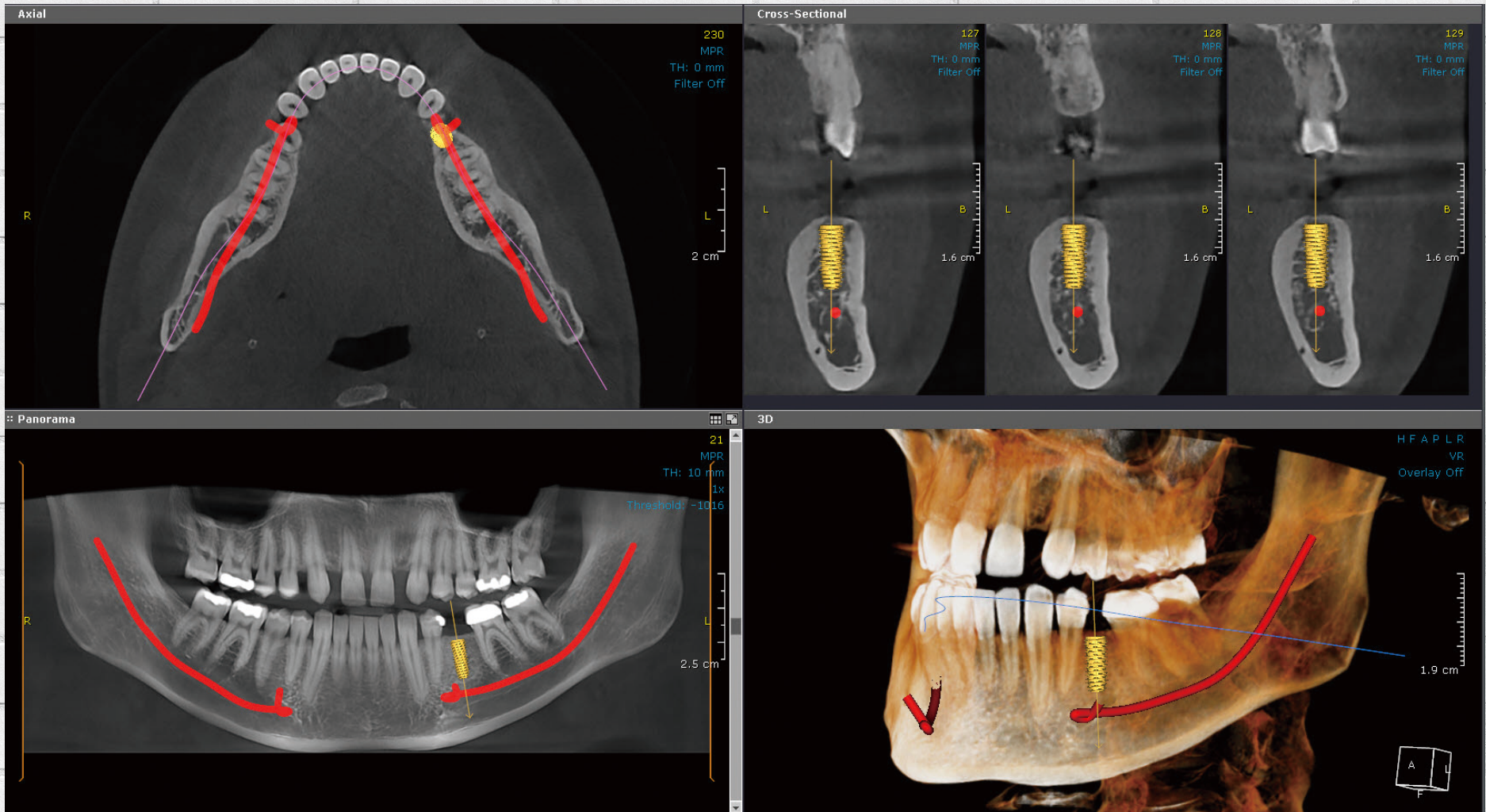

Bone Measurement



Placement Verification

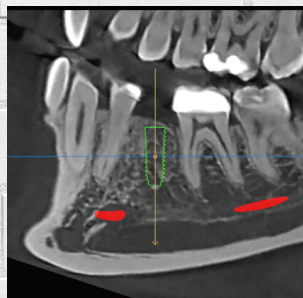

Evaluate Bone Density

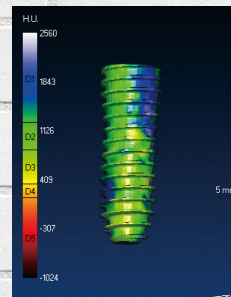

Post Op Check-Up

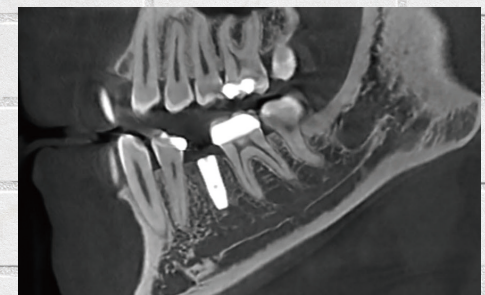

# Oral Surgery

Wide views to evaluate impactions and surrounding anatomy

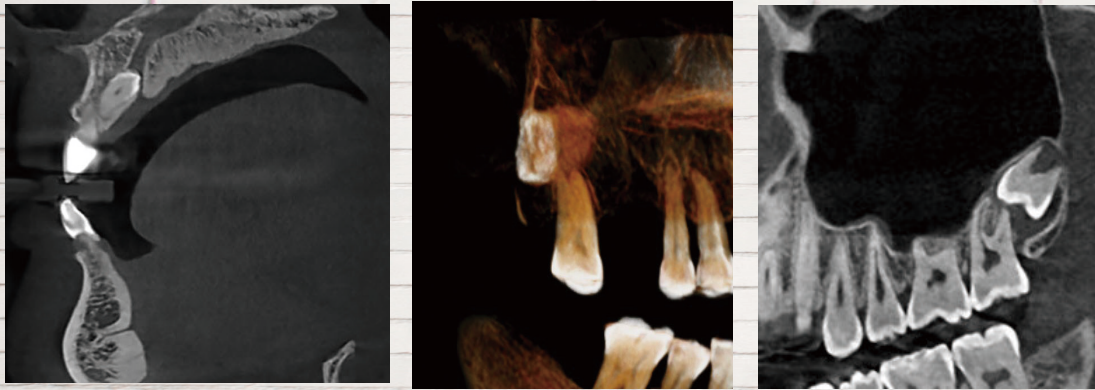

# Endodontics

Endoscopic for C-shape canal

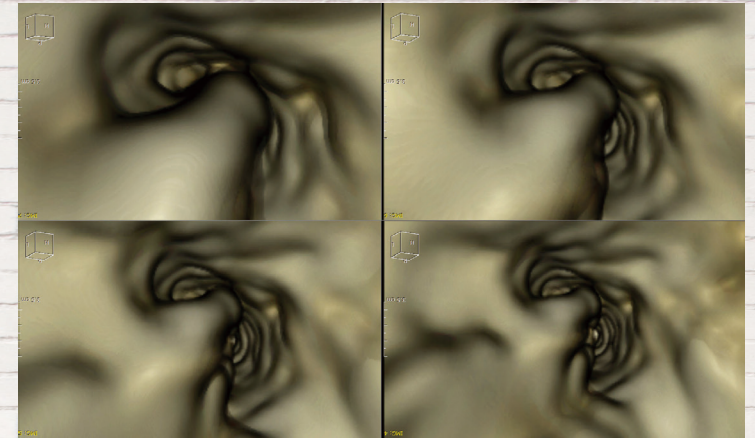

# TMJ

Multilayer view of diagnosis of TMJ ankylosis & mandibular fossa

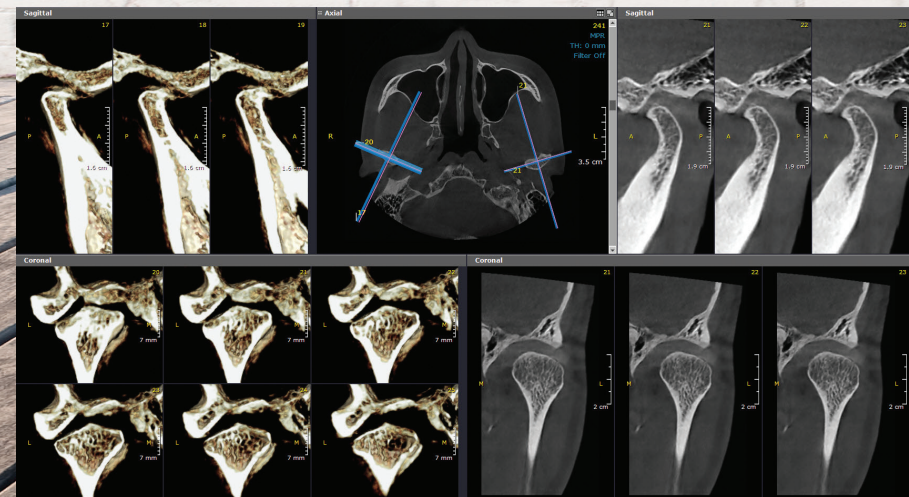
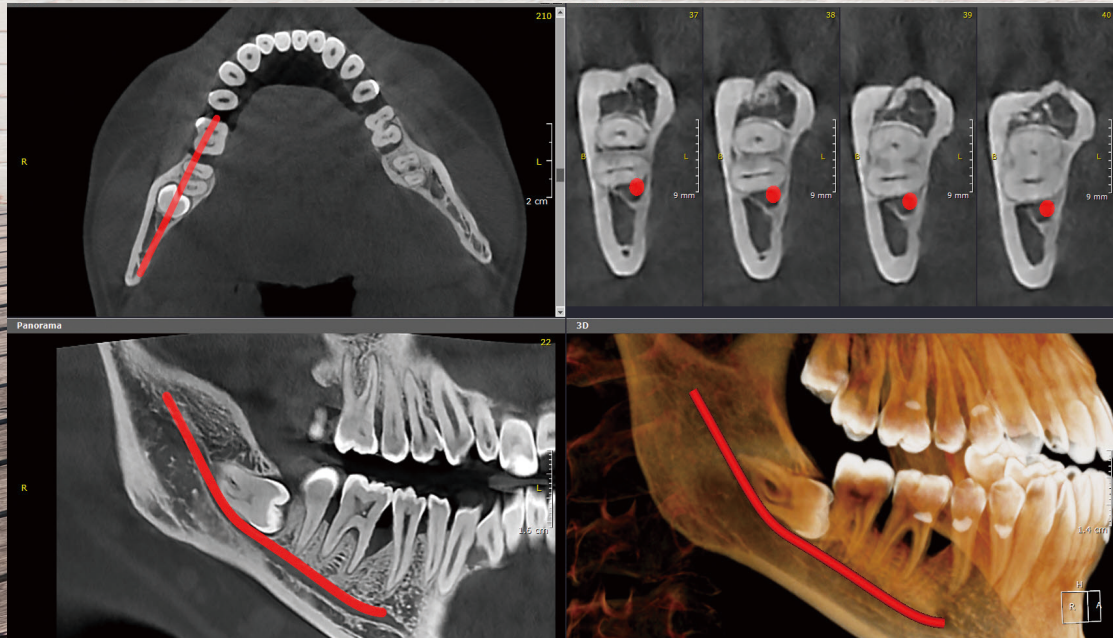



# Otolaryngology

Expanded view for airway, sinus, and ear diagnosis

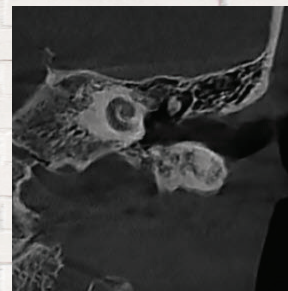
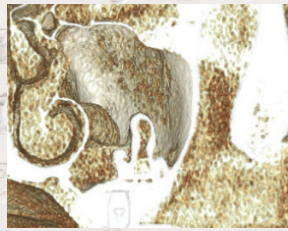
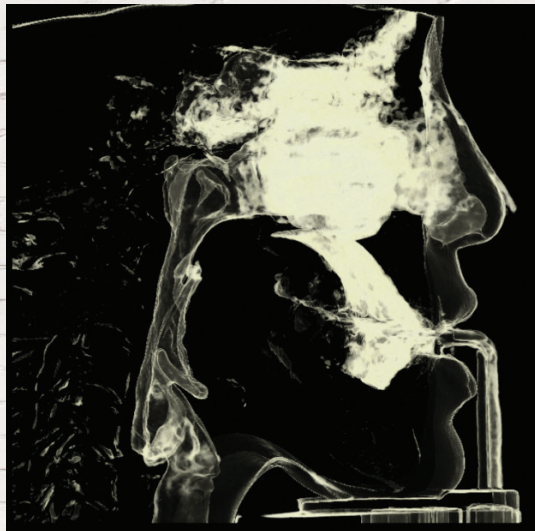

# Orthodontics

3D view without distortion for skeletal & asymmetric analysis

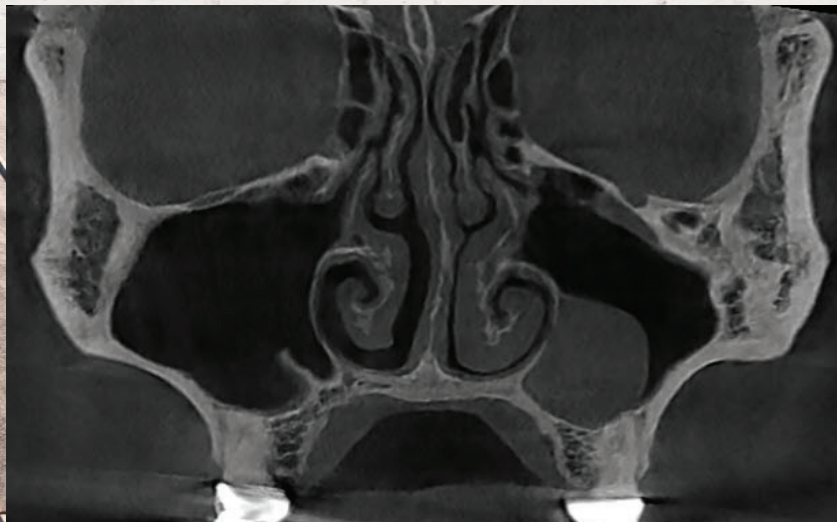

# Dedicated 2D Panorama

*Impeccable wide image view for diagnosis*



*Four cut series of  
TMJ open/closed  
mouth*

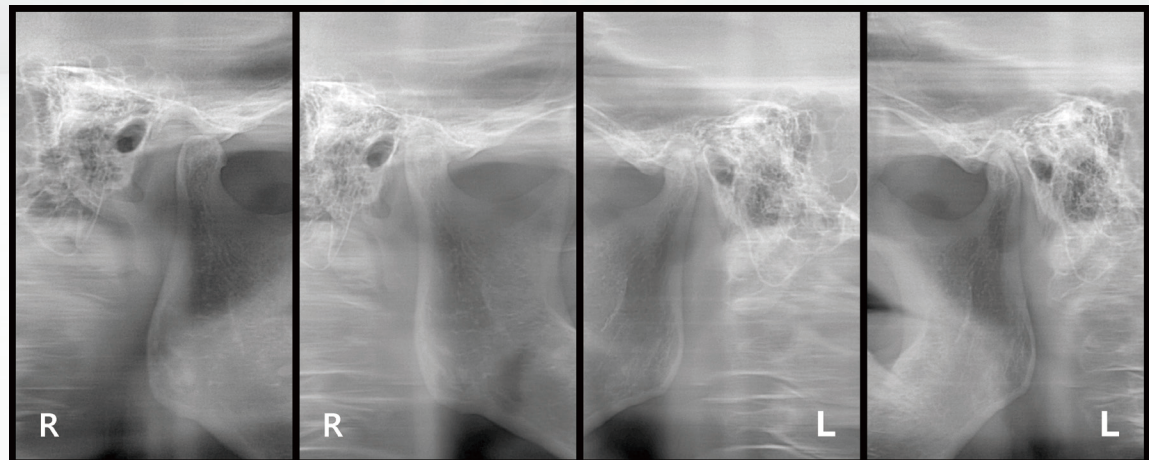

# Cephalometric X-Ray

Two Selections

**Dentri C  $\alpha^{\text{TM}}$**  Our premier one-shot extension provides superior image quality by reducing movement artifacts.

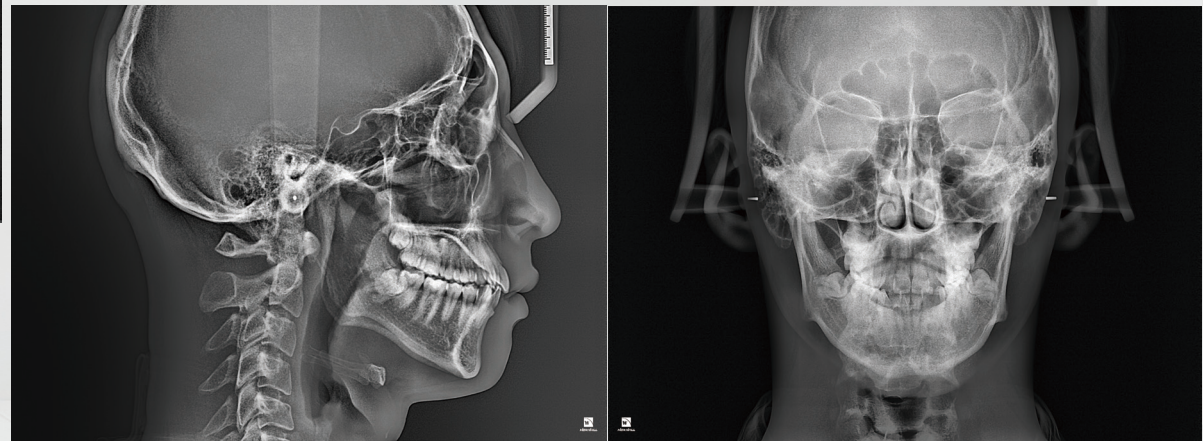
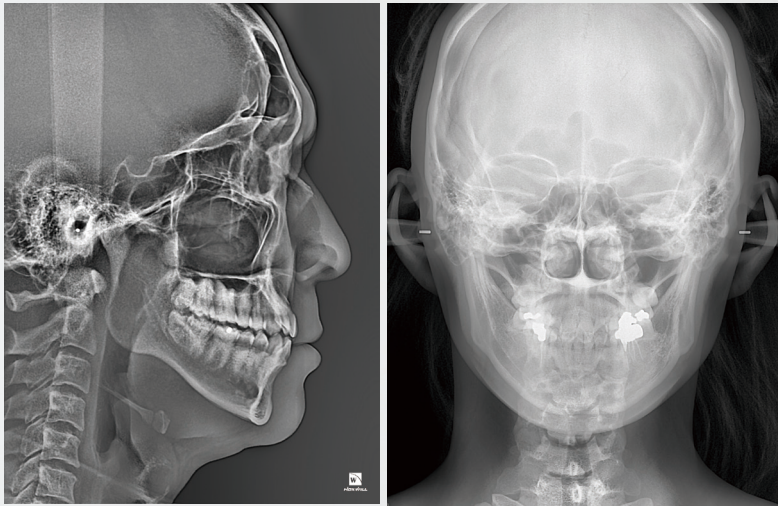

**Dentri S  $\alpha^{\text{TM}}$**

Our standard scanning extension provides excellent diagnostic images

# Dentri $\alpha$ <sup>TM</sup> intuitive software package includes OnDemand3D<sup>TM</sup>



Powerful, 3D, user-friendly, navigation software for digital treatment planning



# Available Software

## Will-Master

Patient image management software and 2D Viewer. Allows you to import and export images from your own practice. Compatible with 3D viewer navigation software.

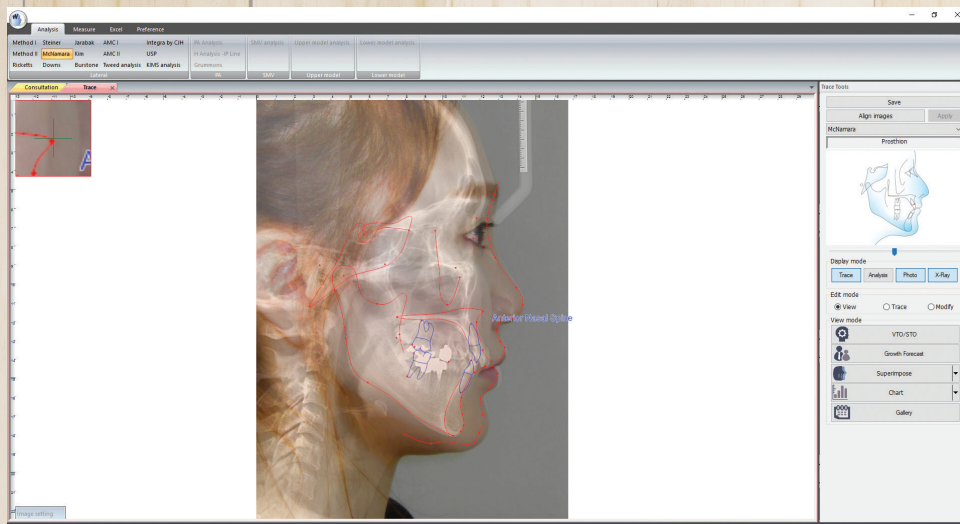

## 3D Cephalometric Analysis Module

The next generation cephalometric analysis with large FOV to evaluate cephalometric landmarks. (Opt.)

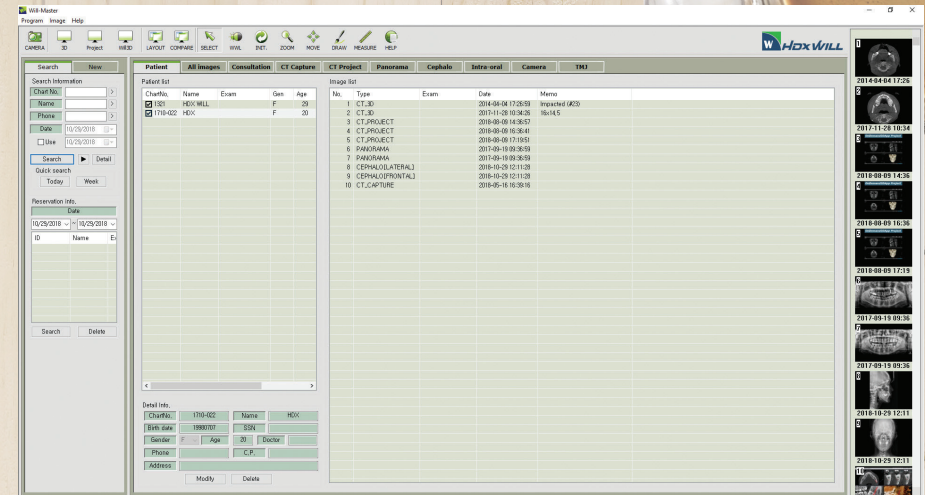

## Will-Ceph

2D Cephalometric analysis software (Opt.)

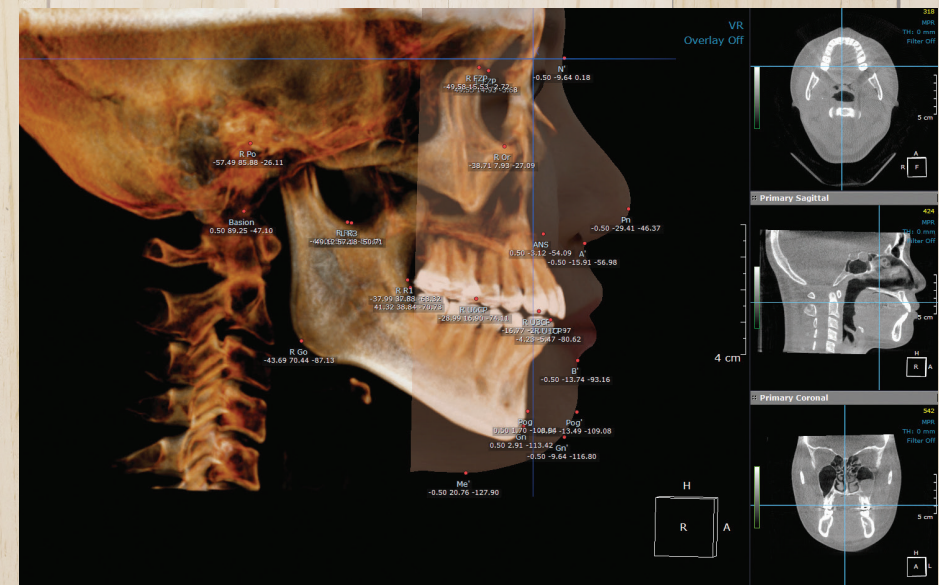

# HDX WILL™ More Than 35 Years of Medical & Dental Experience

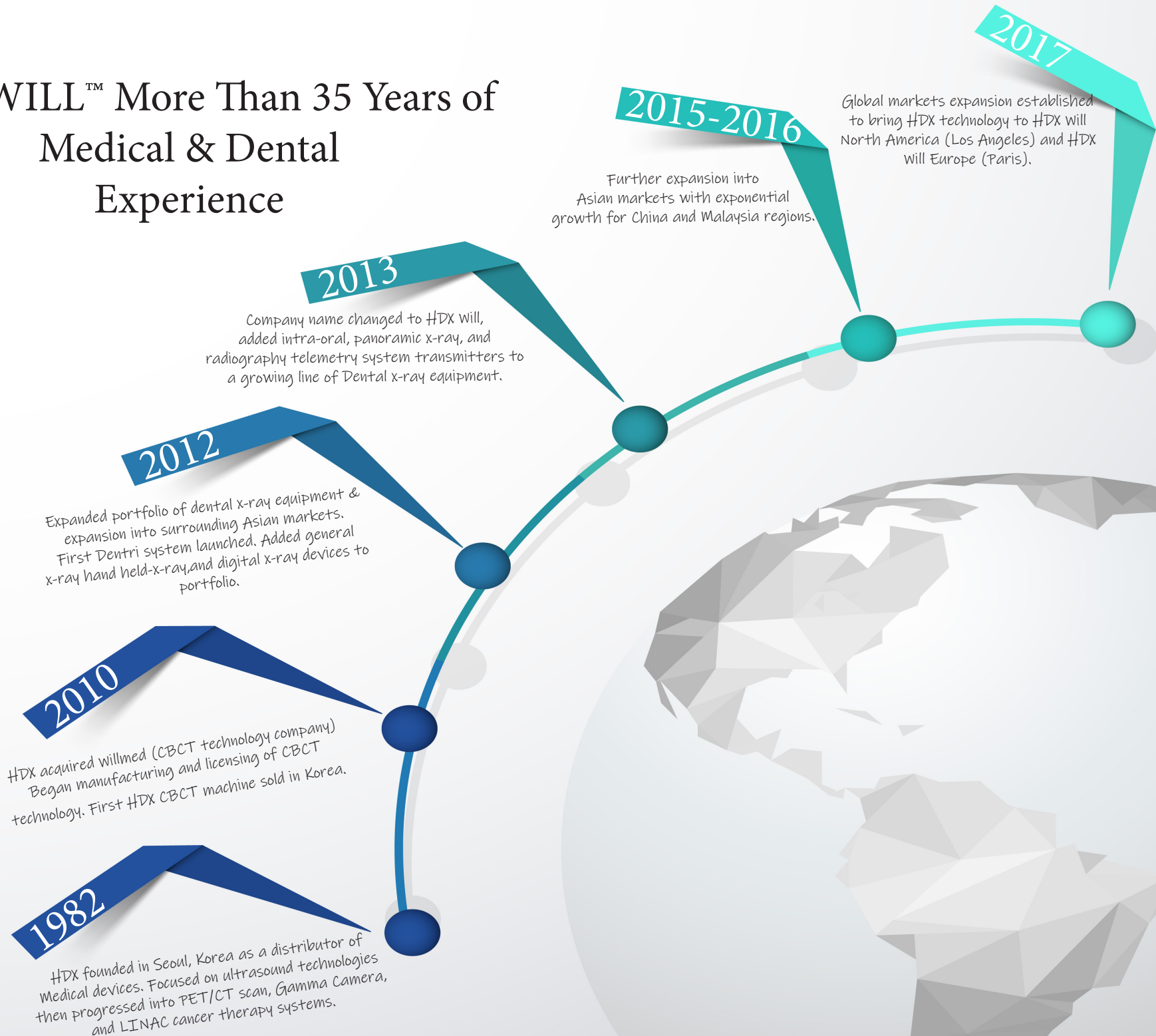

# Minimum Space Required & Dimensions

DENTRI α™ : PANO/CBCT

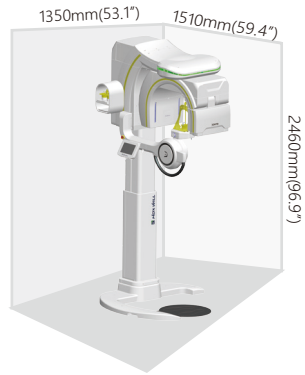

DENTRI C α™ : PANO/CBCT/ONE-SHOT CEPH

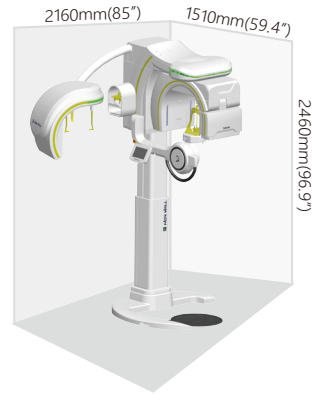

DENTRI S α™ : PANO/CBCT/SCAN CEPH

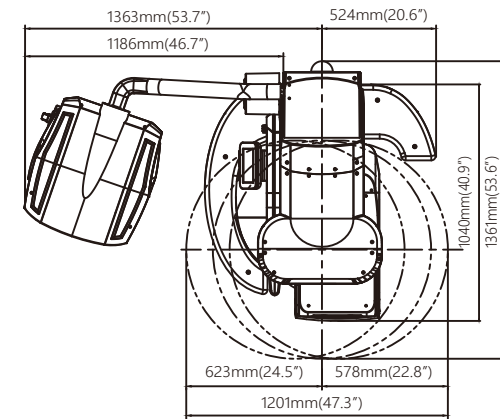
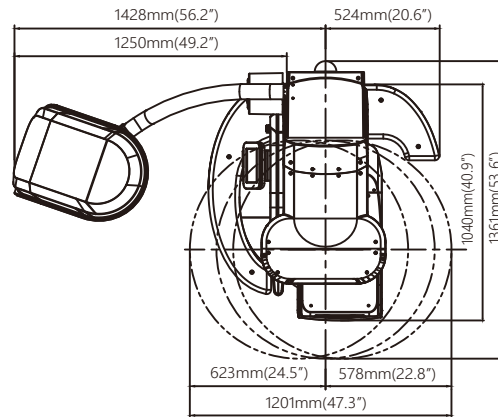
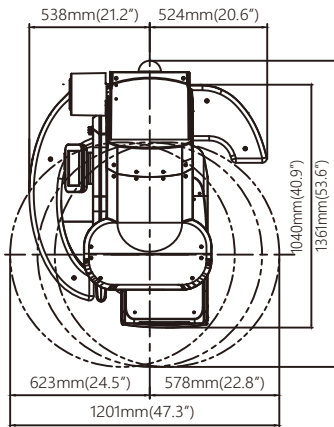
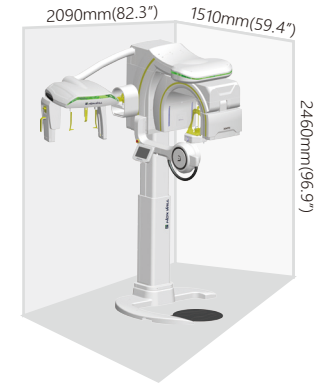

## Product Details

Model		Panorama	Cephalo		CT	FOV (cm x cm)		
			One-Shot	Scan		16 x 14.5	Free FOV	16 x 8
DENTRI α	Extended	●			●	●	●	
	Classic	●			●	●	●	
DENTRI-Cα	Extended	●	●		●	●	●	
	Classic	●	●		●	●	●	
DENTRI-Sα	Extended	●		●	●	●	●	
	Classic	●		●	●	●	●	

# SPECIFICATIONS

X-ray Beam			Cone Beam	Patient Position		Standing (Wheelchair accessible)
Scan Time	CT (Pulsed)	Dentri Classic (16x8cm)	8s(Ultra Fast Scan) 24s(Normal Scan)	Detector Type	CT & Panorama	CMOS
		Dentri Extended (16x14.5cm)	16s(Ultra Fast Scan) 36s(Normal scan)			
	Panorama		14s and less		One-shot Type Cephalo	Direct(TFT)
	One-shot Type Cephalo		0.5s, 1.0s, 1.5s, 2.0s		Scan Type Cephalo	TDI CCD
Field of View (CT)(cm x cm) (Diam. x Height)	Dentri α Classic		Free FOV Max 16x8	Gray Scale	CT & Panorama	14 bits
	Dentri α Extended		Free FOV Max 16x14.5		One-shot Type Cephalo	14 bits
Voxel Size(CT)(mm)		0.10, 0.15, 0.20, 0.25, 0.30		Dimension (mm x mm x mm)(in x in x in) (WxDxH) (Tolerance : ± 5%)	Dentri α: 1201 x 1361 x 2455 (47.3" x 53.6" x 96.65")	
Focal Spot (mm)		0.5			Dentri C α: 2006 x 1361 x 2455 (78.97" x 53.6" x 96.65")	
Reconstruction Time		Minimum 8s (Standard Recon, MAR off)			Dentri S α: 1941 x 1361 x 2455 (76.41" x 53.6" x 96.65")	
Patient Alignment		Vertical Column (optional) : Electric motion Column : Electric motion Temple Support : Motion		System Weight (Tolerance : ± 10%)	Dentri α: 243 kg / 536 lbs (Dentri α Extended) 233 kg / 514 lbs (Dentri α Classic)	
Control Device		Alignment : Touch Panel Exposure & Imaging Acquisition: Workstation			Dentri C α: 270 kg / 595 lbs (Dentri α Extended) 260 kg / 573 lbs (Dentri α Classic)	
Install		Free Standing			Dentri S α: 260 kg / 573 lbs (Dentri α Extended) 243 kg / 536 lbs (Dentri α Classic)	
Tube Voltage		60kVp-110kVp		Workstation	OS	Windows 10 64-bit
Tube Current		5mA-10mA			Memory	16Gb



3435 Wilshire Blvd. Suite 3070  
Los Angeles, CA 90010  
1-888-850-8810  
www.hdxwillna.com

Like us on Facebook!  
Follow us on LinkedIn & Youtube!



LinkedIn: HDX WILL North America  
Facebook : HDX WILL North America  
You Tube : HDXACADEMY



Teahwa Bldg 29, Insa-dong 5-gil,  
Jongno-gu, Seoul, Korea  
82-2-1544-5735  
www.hdxwill.com