



DESS

> DENTAL SMART SOLUTIONS



CATALOGUE 2019/3

NEW PRODUCTS



Dear Customer

We're pleased to introduce you to our new 2019 range of products. In this catalogue you'll find the already well known and proven 100% compatible DESS connections, and the all new innovations we're bringing to the market this quarter.

2018 was a landmark year, we celebrated 10 years of the launch of the DESS Brand, we've increased our manufacturing capabilities adding eight new machines; we launched new compatibilities, incorporated new members to our extended network of distributors and opened new markets.

All this has been possible thanks to innovation, quality, affordability, product range and closeness to our customer needs. Our range of products is second to none and with the best quality and precision available.

At Terrats Medical we're focused on creating the most comprehensive range of compatible prosthetic solutions, our aim is to give you under one brand as many alternatives as possible.

We're the only manufacturer of compatible prosthetic solutions that can proudly say that our products are fully compatible with the originals and that our screws, crucial element in the reconstruction has been engineered to perfection, it has a perfect fit with the original implant and can be adjusted using the original tools without any compromise.

The pure switch concept, is the core essence of our products philosophy, this means all the products that we design and manufacture are fully exchangeable with OEM parts, giving you peace of mind, this is reinforced by the visual check of 100% and the lifetime warranty of all our products, which shows the dedication, professionalism and attention to detail we put in the manufacturing of our products.

For 2019 we have very exiting plans to keep bringing key and relevant products to the market.

We like to thank you for your trust and we hope we can continue this journey together.

Sincerely



Roger Terrats
COO

PRODUCT LIST

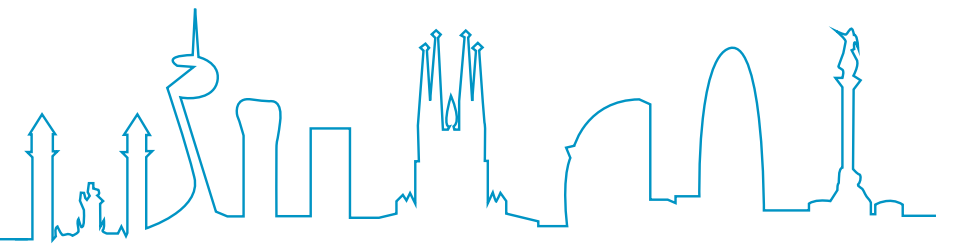



 **ACTIVE HEX**
FITS
NOBELACTIVE® &
NOBELREPLACE® CC 18

 **TRI-LOBE**
FITS
NOBEL REPLACE
SELECT™ 22

 **EXTERNAL HEX UNIVERSAL**
FITS
NOBELBRÅNEMARK® 26

 **EXTERNAL HEX USA**
FITS
3i OSSEOTITE® 30

 **INTERNAL HEX "CLICK"**
FITS
3i CERTAIN® 34

 **OCTAGON**
FITS
STRAUMANN® SOFT
TISSUE LEVEL &
synOCTA® 38

 **CONICAL BL**
FITS
STRAUMANN®
BONE LEVEL 42

 **INTERNAL HEX USA**
FITS
ZIMMER
SCREW-VENT® 46

 **CONIC EVO**
FITS
ASTRA TECH IMPLANT
SYSTEM™ EV 50

 **INTERNAL HEX CONIC**
FITS
ASTRA TECH
OSSEOSPEED™ 54

 **INTERNAL HEX FD**
FITS
DENTSPLY
FRIADENT XIVE® 58

 **INTERNAL ANK**
FITS
DENTSPLY
ANKYLOS® C/X 62

 **CONIC OSS**
FITS
OSSTEM® TS 66

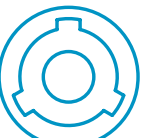
 **INTERNAL CAM**
FITS
CAMLOG® 68

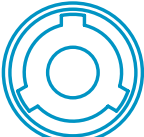
 **INTERNAL CON**
FITS
CONELOG® 72

 **INTERNAL HEX BH**
FITS
BIOHORIZONS®
INTERNAL 74

 **EXTERNAL HEX BH**
FITS
BIOHORIZONS®
EXTERNAL 76

 **INTERNAL HEX MI**
FITS
MIS® SEVEN 80

 **CONIC MC**
FITS
MIS® C1 84

 **CONIC MV**
FITS
MIS® V3 86

 **CONIC ANYR**
FITS
MEGAGEN AnyRidge® 88

 **CONIC AXIO**
FITS
ANTHOGYR AXIOM® 90

 **CONIC IC**
FITS
MEDENTIS ICX® 92

 **CONIC INK**
FITS
GLOBALD IN-KONE® 94

 **CONIC DENT**
FITS
DENTIUM
SUPERLINE™ &
IMPLANTIUM® 96

 **INTERNAL SEM**
FITS
BEGO Semados® 98

 **CONIC BIO**
FITS
BIOTECH KONTACT® 100 NEW

 **INTERNAL BT**
FITS
BTI® 102 NEW

 **MULTI-UNIT CONNECTION**
104

 **DESSLoc**
110

 **PRE-MILLED BLANKS & HOLDERS**
116

 **TOOLS**
122

 **CLINICAL SCREWS
RECOMMENDED
TORQUE** 124



 **DESS**
DENTAL SMART SOLUTIONS

Barcelona
Barcelona

Welcome to **DESS**

Located in Barcelona, Spain our HQ of 6,500m² is one of the most modern manufacturing facilities in Europe

“Staying true to our history and values empowers our brand”

Some Key dates of our company history:

- 1947 Founded in Barcelona. Manufacture of precision mechanical components.
- 1970 70% of production using Swiss-style automatic lathes.
- 1988 First purchase of a Japanese numerical control Okuma CNC lathe.
- 1997 First Japanese Okuma CNC machining.
- 1999 First incorporation of DECO lathes specialized in micro precision machining.
- 2000 ISO 9001 Certification. 2003 100% of production using numerical control CNC machines.
- 2004 First production of dental implant components.
- 2008 Creation of the sanitary department with its own clean room.
 - Sanitary certificate ISO 13485 and CE.
 - Creation of the DESS Dental Smart Solutions brand.
- 2009 SelectGrip® Patent for surface finishes. 200% proven increased retention of cemented crown.
- 2011 DESS already has a presence in 16 countries around the world.
- 2012 Creation of DESS GmbH in Düsseldorf, Germany.
- 2013 DESS already has a presence in 26 countries around the world.
- 2014 DESS LAB starts offering one piece custom abutments.
- 2015 Health Canada approval.
- 2016 We completed the full assortment of angulated multiunits.
 - We launched a revolutionary intraoral scan abutment, without hole on top.
 - METALIVE® is accepted by the regulatory bodies as the unique surface offering real soft tissue attachment and finally available in Europe.
 - 2016 DESS is present in 34 countries worldwide.
- 2017 Achievement of FDA.
 - Relocation of manufacturing plant and offices with a total of 6500m².
- 2018 We launch our angulated screw channel solution "AURUMBase®".
 - Resellers in 41 countries.
 - 100% Increase of the production.

Since our beginnings quality has been quintessential to our philosophy and is reflected in every product that we manufacture. Our choice of the best Swiss and Japanese milling machines allow us to create the most precise parts. Our quality standards entails measuring to a few microns of precision.

“Great things are done by a series of small things brought together”



A business without quality will not last. Terrats Medical is in its third generation and we want to honour our heritage with the highest requirements on quality in all we do.



“The difference between something good and something exceptional is in the smallest detail”

At DESS® we believe that no detail is too small to escape close attention. That's why our exhaustive quality controls in every single part of the manufacturing process ensure that the quality of our products is guaranteed. Our confidence is such that we offer a lifetime warranty on all our products.

We are proud to say that innovation and quality are at the center of our core values. We look at different solutions and re-engineer them to provide better and more reliable alternatives. Products like our intra-oral scan abutment without a screw hole, which improves substantially the image precision, our angled Multiunit abutment with a fully shaped connection and vertical access for more stability and less screw loosening or our angulated screw channel solution AURUMBase® that allows you 25° angle with a 360° rotation, are clear examples of our way of doing things.

“There is no good idea that cannot be improved”



IMPLANTOLOGICAL PHASE



Implant in patient

identify it to use the correct abutments

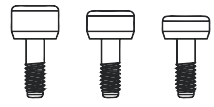

Healing abutments

ref. 20.xxx/y

IMPRESSION TAKING / CLINIC

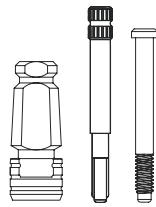

Transfer for open and closed tray

ref. 17.xxx

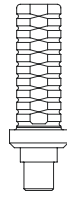

Temporary abutment

ref. 24.xxx and 25.xxx

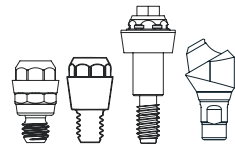

Converter, UniAbutment® and Multi-unit® abutment

ref. 34.00x, 35.001, 40.xxx/y, 41.xxx/y and 43.xxx/y



Clinical screw

ref. 19.xxx



Intra-oral scan abutment

ref. 52.xxx

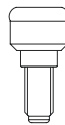

DESS LOC

ref. 88.xxx/y

LABORATORY PHASE



Analogue for implant and abutment

ref. 14.xxx



Scan abutment

ref. 50.xxx

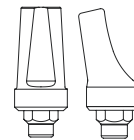

Straight, angled and custom abutment

ref. 13.xxx
ref. 22.xxx and 23.xxx
ref. 51.xxx

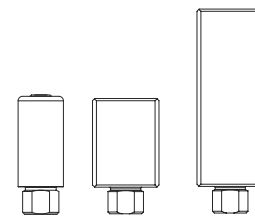

Pre-milled blanks

ref. 61.xxx and 62.xxx
63.xxx
ref. 71.xxx

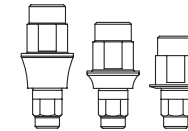

Ti base

ref. 15.xxx and 16.xxx



DESS AURUMBase®

ref. 36.xxx and 37.xxx

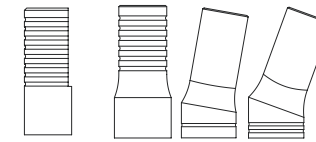

Plastic sleeves for Ti base and AURUMBase®

ref. 32.xxx and 33.xxx
ref. 33.1xx

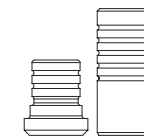

CoCr base with castable

ref. 30.xxx and 31.xxx

for welding techniques

ref. 30.1xx and 31.1xx

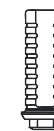

Castable

ref. 28.xxx and 29.xxx

TOOLS & MATERIALS

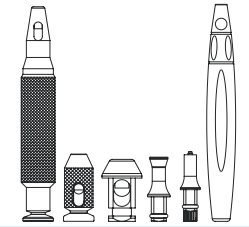

Screwdriver handles and special tools

ref. MDTxxx, PHxxx and DTxxx



Screwdriver tips for different screw head types

ref. DTxxx

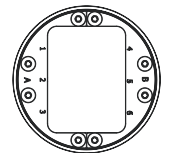

Holders for different milling machines

ref. HLDxx



CoCr Ingots

ref. CRCO1000

ACTIVE HEX

compatible with

NobelActive® / Replace® CC

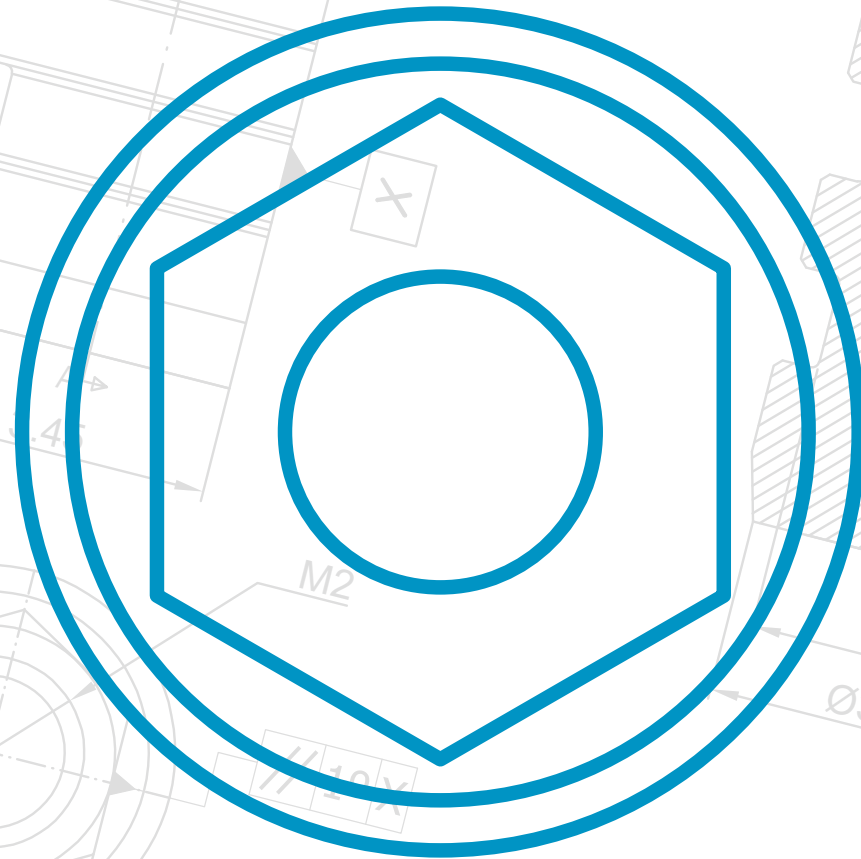

Screw UG



more alternatives in the special design screws section

- Pack of 10
- DLC coated
- NEW** TIN coated

DESS
prosthetic platform
NobelActive® / Replace® CC
equivalent prosthetic platform

	3.0	NP	RP	WP
	SILVER	PURPLE	YELLOW	BLUE
	3.0	3.5	4.3	5.5
	19.068	19.027	19.030	19.030
		19.027-P10	19.030-P10	19.030-P10
	19.268	19.227	19.230	19.230
	19.668	19.627	19.630	19.630

Analogue

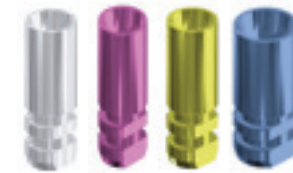

NEW
COLORS

Pack of 10

	3.0	NP	RP	WP
	14.068	14.041	14.042	14.069
		14.041-P10	14.042-P10	

Our analogues are suitable for both 3D and traditional models.

Ti base



		GH		
		1,2mm	●	15.041 15.042
		1,5mm	●	15.068 15.069
	NEW	3,0mm	●	15.341 15.342
		1,2mm	●	16.041 16.042
		1,5mm	●	16.068 16.069
	NEW	3,0mm	●	16.341 16.342

Ti base Castables



Pack of 5

	●	32.001-P5	32.001-P5	32.001-P5	32.001-P5
	●	33.001-P5	33.001-P5	33.001-P5	33.001-P5

CoCr base



	●		30.041	30.042
	●		31.041	31.042

DESS CoCr Ingots



1kg CRCO1000

AURUMBase®

NP
PURPLE
3.5

RP
YELLOW
4.3



Torx® Screw

19.441 19.442

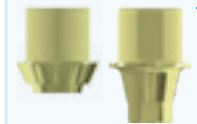

DESS
AURUMBase®

● 36.041 36.042
● 37.041 37.042



Plastic sleeves for
AURUMBase®

Pack of 5 0° 33.100-P5 33.100-P5
Pack of 5 10° 33.101-P5 33.101-P5
Pack of 5 20° 33.102-P5 33.102-P5

Torx® ball Screwdriver DT20TB06 20 mm DT24TB06 24 mm DT35TB06 35 mm



spherical head for angulated screw channels up to 25°



Castable



DESS
prosthetic platform
NobelActive® / Replace® CC
equivalent prosthetic platform

3.0 NP RP WP
SILVER 3.0 PURPLE 3.5 YELLOW 4.3 BLUE 5.5

	●	28.041	28.042
Pack of 10		11.041-P10	11.042-P10
	●	29.041	29.042
Pack of 10		12.041-P10	12.042-P10

Transfer



17.044 17.045

Temporary abutments



● 24.041 24.042
● 25.041 25.042

Abutments



Straight		13.041	13.042
Angled	15°	22.041	22.042
	25°		23.042

Healing abutment



3,0mm ^A	20.039/3	20.040/3
3,0mm ^B	20.047/3	20.048/3
4,0mm ^A	20.039/4	20.040/4
4,0mm ^B	20.047/4	20.048/4
5,0mm ^A	20.039/5	20.040/5
5,0mm ^B	20.047/5	20.048/5

^A for single crown restoration

^B for bridges and structures restoration

DESSLoc®



1,0mm	88.039/1	88.040/1
2,0mm	88.039/2	88.040/2
3,0mm	88.039/3	88.040/3
4,0mm	88.039/4	88.040/4

To see all the DESSLoc® available please refer to page 110

Scan abutments



for desktop scanning <i>* use indicated screw</i>	50.068 * 19.068	50.041 * 19.027	50.042 * 19.030	50.069 * 19.030
for intra-oral scanning	52.068	52.041	52.042	52.069
on Ti base				
	●	53.100-P10	53.100-P10	53.100-P10
Pack of 10	●	53.200-P10	53.200-P10	53.200-P10

● non-engaging

● engaging

Pre-milled blank



DESS
prosthetic platform
NobelActive® / Replace® CC
equivalent prosthetic platform

3.0 NP RP WP
SILVER 3.0 PURPLE 3.5 YELLOW 4.3 BLUE 5.5

Ti	●	∅10mm	61.068	61.041	61.042	61.069
	● NEW	∅14mm		62.041	62.042	62.069
CoCr		∅14mm	71.068	71.041	71.042	71.069

To see all the Pre-milled blank available please refer to page 116

Multiunit abutments



Straight	1,5mm	●	40.007/1	40.008/1
	2,5mm	●	40.007/2	40.008/2
	3,5mm	●	40.007/3	40.008/3
	4,5mm	●		40.008/4



Angled 17°	2,5mm	●	41.707/2	41.708/2
	3,5mm	●	41.707/3	41.708/3

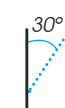

30°	3,5mm	●	43.007/3	43.008/3
	4,5mm	●	43.007/4	43.008/4

To see all the Multiunit abutments available please refer to page 104

Angled Multiunits include DLC SCREW

Special Design Screws

Fits NobelActive® implants and similar implant systems

Our Ref.	Plat.	A	B	C	D	E	F	G	H	I	
19.101 *	NP	★	2,23	0°	0,50	7,35	1,90	2,70	2,75	M1,6	Flat seat screw. Better for bridges, structures and zirconia abutments
19.327	NP	★	2,30	0°		6,95	1,50	2,70	2,75	M1,6	Special screw head design Torx® for angulated screw channels up to 25°
19.328	RP	★	2,60	0°		7,60	1,50	2,10	4,00	M2,0	Special screw head design Torx® for angulated screw channels up to 25°

*Available also in pack of 10

★ UG

★ Torx®

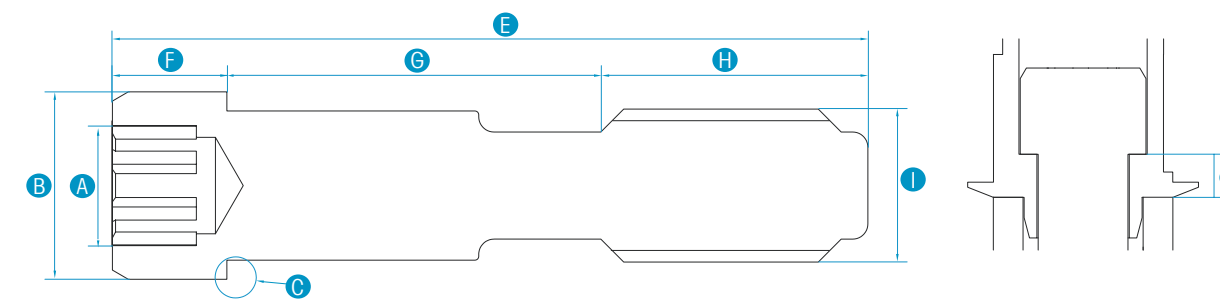

All abutments include final screw, except castables in packs of 10 and scan abutments for desktop scanning

TRI-LOBE

compatible with
Nobel Replace Select™



Screw UG



more alternatives in the special design screws section

Pack of 10
DLC coated
NEW TIN coated

DESS
prosthetic platform
Nobel Replace Select™
equivalent prosthetic platform

	NP	RP	WP	6.0
	PURPLE NP/3.5	YELLOW RP/4.3	BLUE WP/5.0	GREEN 6.0
	19.004	19.005	19.005	19.005
	19.004-P10	19.005-P10	19.005-P10	19.005-P10
	19.204	19.205	19.205	19.205
	19.604	19.605	19.605	19.605

Analogue



Pack of 10

	14.004	14.005	14.006	14.097
	14.004-P10	14.005-P10		

Our analogues are suitable for both 3D and traditional models.

Ti base



NEW

NEW

GH

0,3mm	●	15.004	15.005	15.006	15.097
1,5mm	●	15.204	15.205	15.206	
3,0mm	●	15.304	15.305	15.306	
0,3mm	◀	16.004	16.005	16.006	16.097
1,5mm	◀	16.204	16.205	16.206	
3,0mm	◀	16.304	16.305	16.306	

Ti base Castables



Pack of 5

●	32.001-P5	32.001-P5	32.001-P5	32.001-P5
◀	33.001-P5	33.001-P5	33.001-P5	33.001-P5

CoCr base



DESS CoCr Ingots

1kg CRCO1000

●	30.004	30.005	30.006
◀	31.004	31.005	31.006

AURUMBase®



Torx® Screw

	NP	RP	WP
	PURPLE NP/3.5	YELLOW RP/4.3	BLUE WP/5.0
	19.404	19.405	19.405

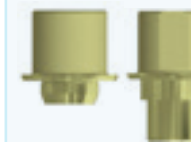

DESS
AURUMBase®

●	36.004	36.005	36.006
◀	37.004	37.005	37.006



Plastic sleeves for
AURUMBase®

Pack of 5	0°	33.100-P5	33.100-P5	33.100-P5
Pack of 5	10°	33.101-P5	33.101-P5	33.101-P5
Pack of 5	20°	33.102-P5	33.102-P5	33.102-P5

Torx® ball Screwdriver	20 mm DT20TB06	24 mm DT24TB06	35 mm DT35TB06
------------------------	-------------------	-------------------	-------------------

spherical head for angulated screw channels up to 25°



Castable

DESS
prosthetic platform
Nobel Replace Select™
equivalent prosthetic platform

NP RP WP 6.0

PURPLE NP/3.5 YELLOW RP/4.3 BLUE WP/5.0 GREEN 6.0

	●	28.004	28.005	28.006
Pack of 10		11.004-P10	11.005-P10	
	◀	29.004	29.005	29.006
Pack of 10		12.004-P10	12.005-P10	

Transfer

		17.004	17.005	17.006
--	--	--------	--------	--------

Temporary abutments

	●	24.004	24.005	24.006
	◀	25.004	25.005	25.006

Abutments

Straight		13.004	13.005	13.006
Angled	15°	22.004	22.005	22.006
	25°		23.005	

Healing abutment

3,0mm		20.004/3	20.005/3	20.006/3
4,0mm		20.004/4	20.005/4	20.006/4
5,0mm		20.004/5	20.005/5	20.006/5

DESSLoc®

1,0mm		88.004/1	88.005/1	
2,0mm		88.004/2	88.005/2	
3,0mm		88.004/3	88.005/3	
4,0mm		88.004/4	88.005/4	

To see all the DESSLoc® available please refer to page 110

Scan abutments

for desktop scanning <i>* use indicated screw</i>		50.004 * 19.004	50.005 * 19.005	50.006 * 19.005	50.097 * 19.005
for intra-oral scanning		52.004	52.005	52.006	52.097
on Ti base Pack of 10	●	53.100-P10	53.100-P10	53.100-P10	53.100-P10
	◀	53.200-P10	53.200-P10	53.200-P10	53.200-P10

● non-engaging ◀ engaging

All abutments include final screw, except castables in packs of 10 and scan abutments for desktop scanning

Pre-milled blank

DESS
prosthetic platform
Nobel Replace Select™
equivalent prosthetic platform

NP RP WP 6.0

PURPLE NP/3.5 YELLOW RP/4.1 BLUE WP/5.0 GREEN 6.0

Ti	∅10mm	61.004	61.005	61.006	61.097
	∅14mm		62.005	62.006	62.097
CoCr	∅14mm	71.004	71.005	71.006	71.097

To see all the Pre-milled blank available please refer to page 116

Multiunit abutments

MULTI-UNIT PLATFORM
4.8

Straight	1,0mm	●	40.004/1	40.005/1	40.006/1	
	2,0mm	●	40.004/2	40.005/2	40.006/2	
	3,0mm	●	40.004/3	40.005/3	40.006/3	
	4,0mm	●		40.005/4		
	5,0mm	●		40.005/5		
Angled 17°	2,0mm	◀	41.704/2	41.705/2		
	3,0mm	◀	41.704/3	41.705/3		
	4,0mm	◀		41.705/4		
	30°	4,0mm	◀		43.005/4	
		4,0mm	●		43.005/4R	
		5,0mm	◀		43.005/5	
5,0mm	●		43.005/5R			

To see all the Multiunit abutments available please refer to page 104

Angled Multiunits include DLC SCREW.

Special Design Screws

Fits Nobel Replace Select™ implants and similar tri-lobe implant systems

Our Ref.	Plat.	A	B	C	D	E	F	G	H	I	
19.304	NP	★	2,50	0°		8,10	1,50	4,00	2,60	M1,8	Special screw head design Torx® for angulated screw channels up to 25°
19.305	RP/WP	★	2,60	0°		9,90	1,50	4,90	3,50	M2,0	Special screw head design Torx® for angulated screw channels up to 25°

★ Torx®

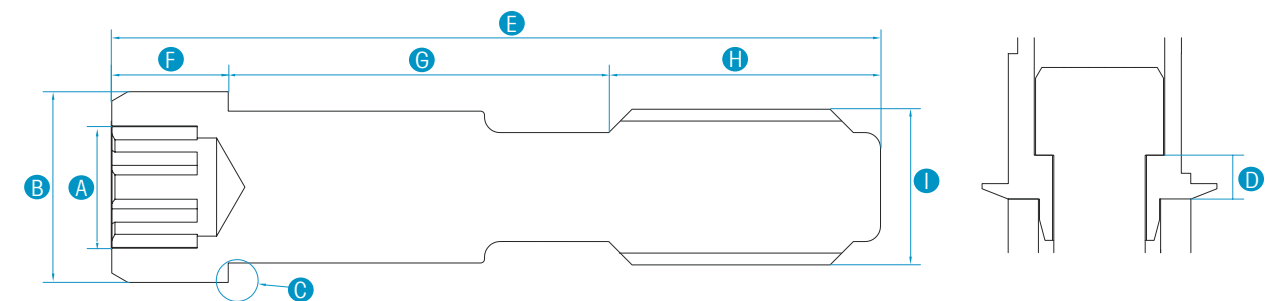

EXTERNAL HEX UNIVERSAL

compatible with
NobelBrånemark®

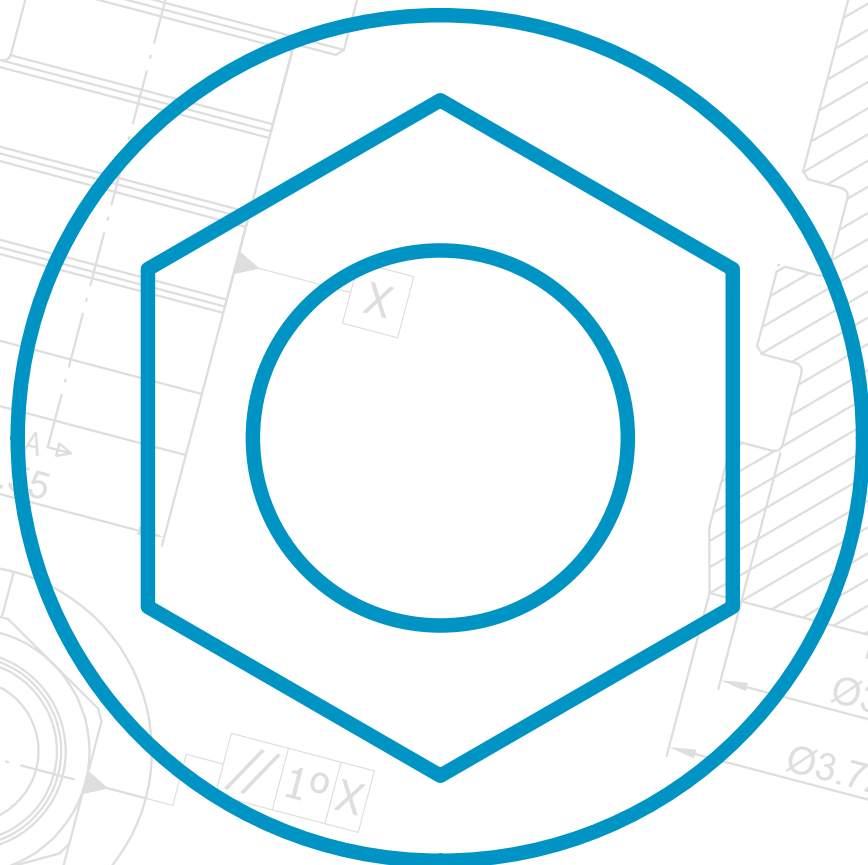

Screw UG



more alternatives in the special design screws section

Pack of 10

DLC coated

NEW TIN coated

DESS
prosthetic platform
NobelBrånemark®
equivalent prosthetic platform

	NP	RP	WP
	NP/3.5	RP/4.1	WP/5.1
	19.027	19.028	19.029
	19.027-P10	19.028-P10	19.029-P10
	19.227	19.228	19.229
	19.627	19.628	19.629

Analogue



Pack of 10

	14.001	14.002	14.003
		14.002-P10	

Our analogues are suitable for both 3D and traditional models.

Ti base



NEW

NEW

GH

0,3mm	●	15.001	15.002	15.003
1,5mm	●	15.201	15.202	15.203
3,0mm	●	15.301	15.302	15.303
0,3mm	●	16.001	16.002	16.003
1,5mm	●	16.201	16.202	16.203
3,0mm	●	16.301	16.302	16.303

Ti base Castables



Pack of 5

●	32.001-P5	32.001-P5	32.003-P5
●	33.001-P5	33.001-P5	33.003-P5

CoCr base



for welding techniques

●	30.001	30.002	30.003
●	31.001	31.002	31.003
●		30.102	

DESS CoCr Ingots



1kg CRCO1000

AURUMBase®



Torx® Screw

NP
NP/3.5

RP
RP/4.1

19.401

19.402



DESS
AURUMBase®

● 36.001 36.002

● 37.001 37.002



Plastic sleeves for
AURUMBase®

Pack of 5

Pack of 5

Pack of 5

0° 33.100-P5 33.100-P5

10° 33.101-P5 33.101-P5

20° 33.102-P5 33.102-P5

Torx® ball Screwdriver

20 mm

24 mm

35 mm

DT20TB06

DT24TB06

DT35TB06



spherical head for angulated screw channels up to 25°



Castable

DESS
prosthetic platform
NobelBrånemark®
equivalent prosthetic platform

NP RP WP
NP/3.5 RP/4.1 WP/5.1



	●	28.001	28.002	28.003
Pack of 10	●		11.002-P10	
	●	29.001	29.002	29.003
Pack of 10	●		12.002-P10	

Transfer



		17.041	17.042	17.043
--	--	--------	--------	--------

Temporary abutments



	●	24.001	24.002	24.003
	●	25.001	25.002	25.003

Abutments



Straight		13.001	13.002	13.003
Angled	15°	22.001	22.002	22.003
	25°		23.002	

Healing abutment



3,0mm	20.001/3	20.002/3	20.003/3
4,0mm	20.001/4	20.002/4	20.003/4
5,0mm	20.001/5	20.002/5	20.003/5

DESSLoc®



1,0mm	88.001/1	88.002/1	
2,0mm	88.001/2	88.002/2	
3,0mm	88.001/3	88.002/3	
4,0mm		88.002/4	
5,0mm		88.002/5	

Scan abutments



for desktop scanning * use indicated screw		50.001 * 19.027	50.002 * 19.028	50.003 * 19.029
for intra-oral scanning		52.001	52.002	52.003
NEW on Ti base	●	53.100-P10	53.100-P10	53.100-P10
Pack of 10	●	53.200-P10	53.200-P10	53.200-P10

● non-engaging ● engaging

All abutments include final screw, except castables in packs of 10 and scan abutments for desktop scanning.

Pre-milled blank

DESS
prosthetic platform
NobelBrånemark®
equivalent prosthetic platform

NP RP WP
NP/3.5 RP/4.1 WP/5.1



Ti	∅10mm	61.001	61.002	61.003
CoCr	∅14mm	71.001	71.002	71.003

To see all the Pre-milled blank available please refer to page 116

Multunit abutments



		MULTI-UNIT PLATFORM			
		4.8	6.5		
Straight	1,0mm ●	40.001/1	40.002/1	40.003/1	
	2,0mm ●	40.001/2	40.002/2	40.003/2	
	3,0mm ●	40.001/3	40.002/3	40.003/3	
	4,0mm ●		40.002/4		
	5,0mm ●		40.002/5		
Angled 17°	2,0mm ●	41.701/2	41.702/2		
	3,0mm ●	41.701/3	41.702/3		
	4,0mm ●		41.702/4		
	30°	4,0mm ●		43.002/4	
		4,0mm ●		43.002/4R	
		5,0mm ●		43.002/5	
	5,0mm ●		43.002/5R		

To see all the Multunit abutments available please refer to page 104

Angled Multiunits include DLC SCREW.

Special Design Screws

Fits NobelBrånemark® implants and similar external hex implant systems

Our Ref.	Plat.	A	B	C	D	E	F	G	H	I	
19.101*	NP	●	2,23	0°	0,50	7,35	1,90	2,70	2,75	M1,6	Flat seat screw. Better for bridges, structures and zirconia abutments.
19.327	NP	★	2,30	0°		6,95	1,50	2,70	2,75	M1,6	Special screw head design Torx® for angulated screw channels up to 25°
19.328	RP	★	2,60	0°		7,60	1,50	2,10	4,00	M2,0	Special screw head design Torx® for angulated screw channels up to 25°
19.329	WP	★	3,40	0°		7,20	1,50	2,70	3,00	M2,5	Special screw head design Torx® for angulated screw channels up to 25°

*Available also in pack of 10

★ Torx®

● UG

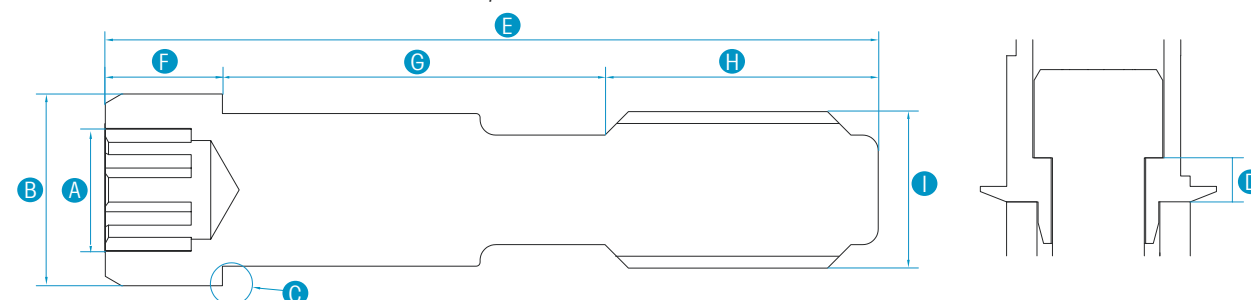

EXTERNAL HEX USA

compatible with
3i Osseotite®



Screw hex



1,20mm

more alternatives in the special design screws section

Pack of 10
NEW TIN coated

DESS
prosthetic platform
3i Osseotite®
equivalent prosthetic platform

	NP	RP	WP
	PURPLE 3.4	BLUE 4.1	YELLOW 5.0
	19.034	19.034	19.034
	19.034-P10	19.034-P10	19.034-P10
	19.634	19.634	19.634

Analogue



Pack of 10

	NP	RP	WP
	14.011	14.012	14.013
		14.012-P10	

Our analogues are suitable for both 3D and traditional models.

Ti base



GH

0,3mm	●	15.011	15.012	15.013
1,5mm	●	15.211	15.212	15.213
3,0mm	●	15.311	15.312	15.313
0,3mm	●	16.011	16.012	16.013
1,5mm	●	16.211	16.212	16.213
3,0mm	●	16.311	16.312	16.313

Ti base Castables



Pack of 5

●	32.001-P5	32.001-P5	32.001-P5
●	33.001-P5	33.001-P5	33.001-P5

CoCr base



DESS CoCr Ingots

1kg CRC01000

●	30.011	30.012	30.013
●	31.011	31.012	31.013

AURUMBase®

NP
PURPLE
3.4

RP
BLUE
4.1

WP
YELLOW
5.0



Torx® Screw

	19.402	19.402	19.402
--	--------	--------	--------



DESS
AURUMBase®

●	36.011	36.012	36.013
●	37.011	37.012	37.013



Plastic sleeves for
AURUMBase®

Pack of 5	0°	33.100-P5	33.100-P5	33.100-P5
Pack of 5	10°	33.101-P5	33.101-P5	33.101-P5
Pack of 5	20°	33.102-P5	33.102-P5	33.102-P5

Torx® ball Screwdriver

20 mm	24 mm	35 mm
DT20TB06	DT24TB06	DT35TB06

spherical head for angulated screw channels up to 25°



Castable

DESS
prosthetic platform
3i Osseotite®
equivalent prosthetic platform

	NP PURPLE 3.4	RP BLUE 4.1	WP YELLOW 5.0
--	---------------------	-------------------	---------------------



Pack of 10	●	28.011	28.012	28.013
			11.002-P10	
Pack of 10	◆	29.011	29.012	29.013
			12.002-P10	

Transfer



		17.011	17.012	17.013
--	--	--------	--------	--------

Temporary abutments



	●	24.011	24.012	24.013
	◆	25.011	25.012	25.013

Abutments



		NP	RP	WP
Straight		13.011	13.012	13.013
Angled	15°	22.011	22.012	22.013
	25°		23.012	

Healing abutment



3,0mm	20.011/3	20.012/3	20.013/3
4,0mm	20.011/4	20.012/4	20.013/4
5,0mm	20.011/5	20.012/5	20.013/5

DESSLoc®



1,0mm	88.011/1	88.002/1	
2,0mm	88.011/2	88.002/2	
3,0mm	88.011/3	88.002/3	
4,0mm	88.011/4	88.002/4	
5,0mm		88.002/5	

Scan abutments



for desktop scanning * use indicated screw		50.011	50.012	50.013
		* 19.034	* 19.034	* 19.034
for intra-oral scanning		52.011	52.012	52.013
on Ti base		53.100-P10	53.100-P10	53.100-P10
Pack of 10	●	53.200-P10	53.200-P10	53.200-P10

● non-engaging ● engaging

Pre-milled blank

DESS
prosthetic platform
3i Osseotite®
equivalent prosthetic platform

	NP PURPLE 3.4	RP BLUE 4.1	WP YELLOW 5.0
--	---------------------	-------------------	---------------------



Ti	∅10mm	61.011	61.012	61.013
CoCr	∅14mm	71.011	71.012	71.013

To see all the Pre-milled blank available please refer to page 116

Multunit abutments



		MULTI-UNIT PLATFORM 4.8		
Straight	1,0mm	●	40.009/1	40.017/1
	2,0mm	●	40.009/2	40.017/2
	3,0mm	●	40.009/3	40.017/3
	4,0mm	●		40.017/4
	5,0mm	●		40.017/5
Angled 17°	2,0mm	◆		41.712/2
	3,0mm	◆		41.702/3*
	4,0mm	◆		41.702/4*
Angled 30°	3,0mm	◆		43.012/3
	4,0mm	◆		43.012/4
	5,0mm	◆		43.012/5

* with DLC screw

To see all the Multunit abutments available please refer to page 104

All abutments include final screw, except castables in packs of 10 and scan abutments for desktop scanning.

Special Design Screws

Fits 3i Osseotite® implants and similar implant systems

Our Ref.	Plat.	A	B	C	D	E	F	G	H	I	
19.106*	RP 4,8	◆	2,25	0°	3,80	4,48	1,75	0,53	2,20	M1,4	Special screw for abutments on 3i® Low Profile Abutment. Can be used for bridges, structures or zirconia abutments

*Available also in pack of 10 Torx® H1,20

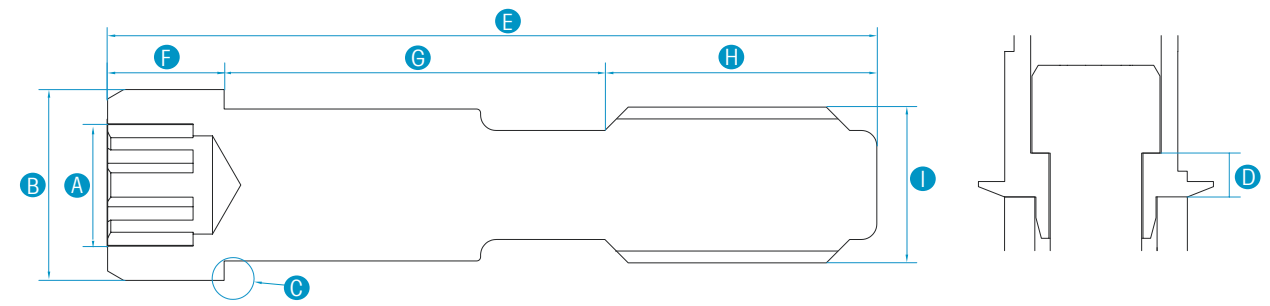

INTERNAL HEX "CLICK" M1,6

compatible with
3i Certain®



Screw hex



1,20mm

more alternatives in the special design screws section

Pack of 10
NEW TIN coated

DESS
prosthetic platform
3i Certain®
equivalent prosthetic platform

	NP	RP	WP
	PURPLE 3.4	BLUE 4.1	YELLOW 5.0
	19.011	19.011	19.011
	19.011-P10	19.011-P10	19.011-P10
	19.611	19.611	19.611

Analogue



Pack of 10

14.014	14.015	14.016
	14.015-P10	

Our analogues are suitable for both 3D and traditional models.

Ti base



	GH				
	0,3mm	●	15.014	15.015	15.016
	1,5mm	●	15.214	15.215	15.216
	3,0mm	●	15.314	15.315	15.316
	0,3mm	●	16.014	16.015	16.016
	1,5mm	●	16.214	16.215	16.216
	3,0mm	●	16.314	16.315	16.316

Ti base Castables



●	32.001-P5	32.001-P5	32.001-P5
●	33.001-P5	33.001-P5	33.001-P5

CoCr base



●	30.014	30.015	30.016
●	31.014	31.015	31.016

DESS CoCr Ingots



1kg CRC01000

AURUMBase®

NP
PURPLE
3.4

RP
BLUE
4.1

WP
YELLOW
5.0



Torx® Screw

19.438	19.438	19.438
--------	--------	--------



DESS
AURUMBase®

●	36.014	36.015	36.016
●	37.014	37.015	37.016



Plastic sleeves for
AURUMBase®

		NP	RP	WP
Pack of 5	0°	33.100-P5	33.100-P5	33.100-P5
Pack of 5	10°	33.101-P5	33.101-P5	33.101-P5
Pack of 5	20°	33.102-P5	33.102-P5	33.102-P5

Torx® ball Screwdriver

	20 mm	24 mm	35 mm
	DT20TB06	DT24TB06	DT35TB06



spherical head for angulated screw channels up to 25°



Castable



DESS
prosthetic platform
3i Certain®
equivalent prosthetic platform

NP
PURPLE
3.4

RP
BLUE
4.1

WP
YELLOW
5.0

	●	28.014	28.015	28.016
Pack of 10			11.015-P10	
	●	29.014	29.015	29.016
Pack of 10			12.015-P10	

Transfer



		17.014	17.015	17.016
--	--	--------	--------	--------

Temporary abutments



	●	24.014	24.015	24.016
	●	25.014	25.015	25.016

Abutments



Straight		13.014	13.015	13.016
Angled 15°		22.014	22.015	22.016
Angled 25°			23.015	

Healing abutment



3,0mm		20.014/3	20.015/3	20.016/3
4,0mm		20.014/4	20.015/4	20.016/4
5,0mm		20.014/5	20.015/5	20.016/5

DESSLoc®



1,0mm		88.014/1	88.015/1	
2,0mm		88.014/2	88.015/2	
3,0mm		88.014/3	88.015/3	
4,0mm		88.014/4	88.015/4	

To see all the DESSLoc® available please refer to page 110

Scan abutments



for desktop scanning * use indicated screw		50.014 * 19.011	50.015 * 19.011	50.016 * 19.011
for intra-oral scanning		52.014	52.015	52.016
on Ti base		53.100-P10	53.100-P10	53.100-P10
Pack of 10	●	53.200-P10	53.200-P10	53.200-P10

Pre-milled blank



DESS
prosthetic platform
3i Certain®
equivalent prosthetic platform

NP
PURPLE
3.4

RP
BLUE
4.1

WP
YELLOW
5.0

Ti	●	61.014	61.015	61.016
CoCr	●	71.014	71.015	71.016

To see all the Pre-milled blank available please refer to page 116

● non-engaging ● engaging

All abutments include final screw, except castables in packs of 10 and scan abutments for desktop scanning

Special Design Screws

Fits 3i Certain® implants and similar implant systems

Our Ref.	Plat.	A	B	C	D	E	F	G	H	I	
19.106*	RP	●	2,25	0°	3,80	4,48	1,75	0,53	2,20	M1,4	Special screw for abutments on 3i® Low Profile Abutment. Can be used for bridges, structures or zirconia abutments
19.311	all	★	2,30	0°		8,10	1,50	4,00	2,70	M1,6	Special screw head design Torx® for angulated screw channels up to 25°

*Available also in pack of 10 ★ Torx® ● H1,20

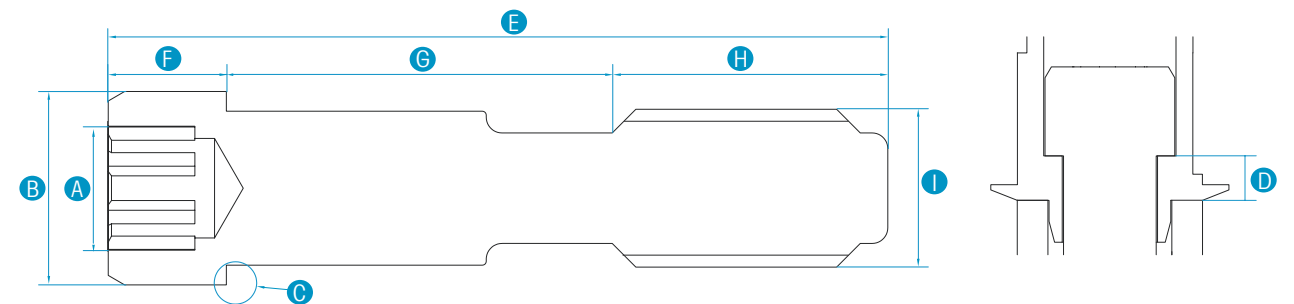

OCTAGON

compatible with

Straumann® Tissue level & synOCTA®

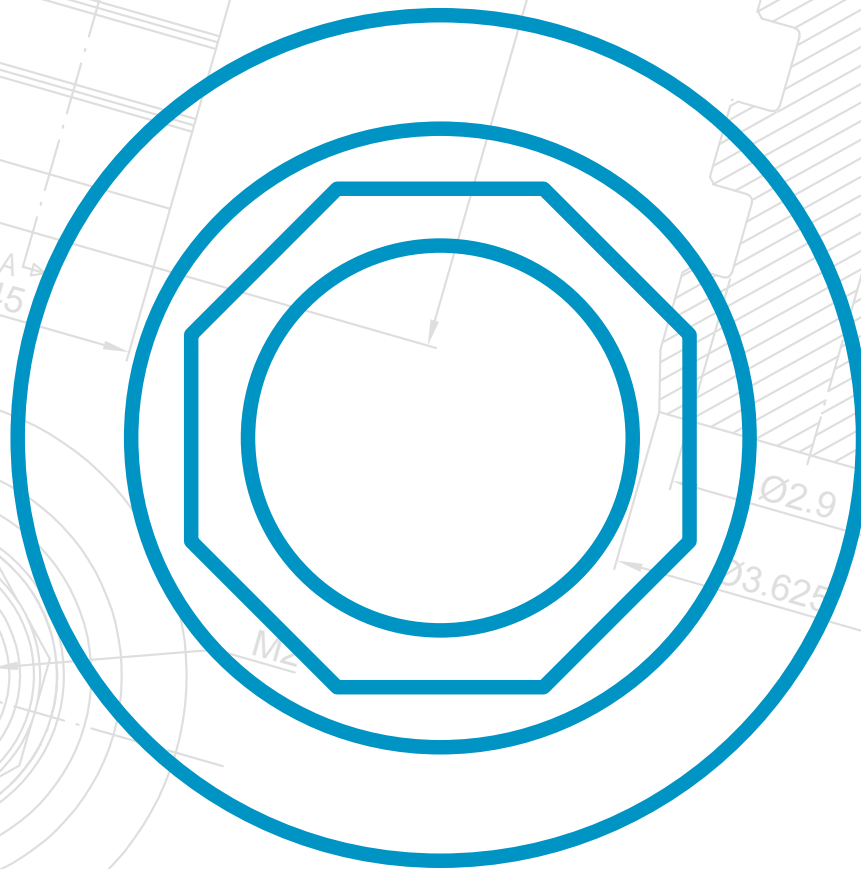

Screw Torx®



more alternatives in the special design screws section

Pack of 10

NEW TIN coated



Pack of 10

NEW TIN coated

Analogue



Pack of 10

OF ABUTMENT

Pack of 10

Ti base

GH

Our analogues are suitable for both 3D and traditional models.



NEW

NEW

- 0,3mm
- 0,4mm
- NEW 0,5mm
- 0,3mm
- 0,4mm
- NEW 0,5mm

- 15.045
- 15.046
- 15.070
- 16.045
- 16.009
- 16.070

ON ABUTMENT

- 0,3mm 15.010 15.048
- 0,3mm 16.010 16.048

Ti base Castables



Pack of 5

ON ABUTMENT

Pack of 5

- 32.001-P5 32.046-P5 32.045-P5
- 33.001-P5 33.009-P5 33.045-P5
- 32.010-P5 32.045-P5
- 33.010-P5 33.045-P5

AURUMBase®

RN
RN
4.8

WN
WN
6.5



Torx® Screw

19.446 19.446



DESS
AURUMBase®

36.046 36.047
37.009 37.045



Plastic sleeves for
AURUMBase®

Pack of 5

Pack of 5

Pack of 5

0° 33.100-P5 33.100-P5
10° 33.101-P5 33.101-P5
20° 33.102-P5 33.102-P5

Torx® ball Screwdriver

20 mm

24 mm

35 mm

DT20TB06

DT24TB06

DT35TB06

spherical head for angulated screw channels up to 25°

Up to 25°
Angulated
Screw
Channel



CoCr base



DESS prosthetic platform Straumann® Tissue level & synOCTA® equivalent prosthetic platform		RN	WN
		RN	WN
ON ABUTMENT	●	30.009	30.045
	●	31.009	31.045
	●	30.010	30.048
	●	31.010	31.048
for welding techniques			
ON ABUTMENT	●	30.109	30.145
	●	31.109	31.145
	●	30.110	
	●	31.110	

DESS CoCr Ingots



1kg CRCO1000

Castable



ON ABUTMENT	●	28.009	28.045
	●	11.009-P10	
ON ABUTMENT	●	29.009	29.045
	●	12.009-P10	
ON ABUTMENT	●	28.010	28.046
	●	11.010-P10	
ON ABUTMENT	●	29.010	29.046
	●	12.010-P10	

Transfer

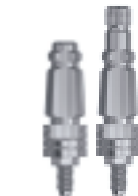

ON ABUTMENT	●	17.009	17.053
	●	17.010	17.048

Temporary abutments



ON ABUTMENT	●	24.026	24.045
	●	25.009	25.045
	●	24.010	24.047
	●	25.026	25.047

Abutments



ON ABUTMENT	Straight	13.009*	
	Angled 15°	22.009*	
	25°	23.009*	

*inc.captive screw

Healing abutment



ON ABUTMENT	2,0mm	20.009/2	20.045/2
	3,0mm	20.009/3	20.045/3
	4,0mm	20.009/4	20.045/4



ON ABUTMENT	●	20.010	20.049
-------------	---	--------	--------

● non-engaging

● engaging

Converter abutment



DESS
prosthetic platform
Straumann® Tissue level & synOCTA®
equivalent prosthetic platform

NNC

RN

WP

NNC
3.5

RN
4.8

WN
6.5

ON ABUTMENT	●	35.001	
	●	34.001	34.002

DESSLoc®



ON ABUTMENT	1,0mm	88.009/1	
	2,0mm	88.009/2	
	3,0mm	88.009/3	
	4,0mm	88.009/4	

To see all the DESSLoc® available please refer to page 110

Scan abutments



for desktop scanning
* use indicated screw

ON ABUTMENT	●	50.070	50.009	50.045
	●		* 19.026	* 19.026
ON ABUTMENT	●	50.010	50.048	
	●	* 19.009	* 19.009	

for intra-oral scanning

ON ABUTMENT	●	52.070	52.009	52.045
	●		52.010	52.048

on Ti base

ON ABUTMENT	●	Pack of 10	53.100-P10	
	●		53.200-P10	

Pre-milled blank



ON ABUTMENT	Ti	●	∅10mm	61.070	61.009	61.045
	CoCr	●	∅14mm		62.009	62.045
ON ABUTMENT	CoCr	●	∅14mm	71.070	71.009	71.045

To see all the Pre-milled blank available please refer to page 116

Special Design Screws

Fits Straumann® Soft Tissue level & synOCTA® implants and similar octagon implant systems

Our Ref.	Plat.	A	B	C	D	E	F	G	H	I	
19.102*	RN/WN	★	2,40	0°	1,30	7,50	2,52	2,28	2,70	M2,0	Flat seat screw. Better for bridges, structures and zirconia abutments
19.103*	RN/WN	★	2,50	0°	3,25	5,10	1,55	0,00	3,55	M2,0	Flat seat screw. Better for bridges, structures and zirconia abutments
19.328	RN/WN	★	2,60	0°		7,60	1,50	2,10	4,00	M2,0	Special screw head design Torx® for angulated screw channels up to 25°

*Available also in pack of 10

★ Torx®

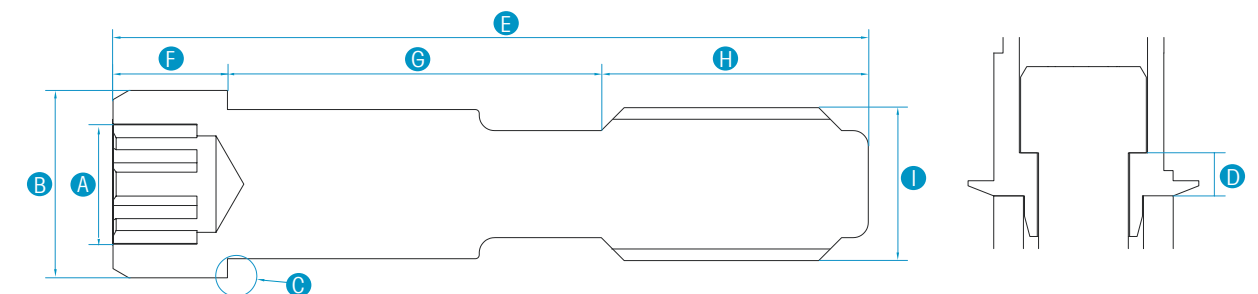

All abutments include final screw. Transfers include two screws (for open and closed tray).

CONICAL BL

compatible with
Straumann® Bone level

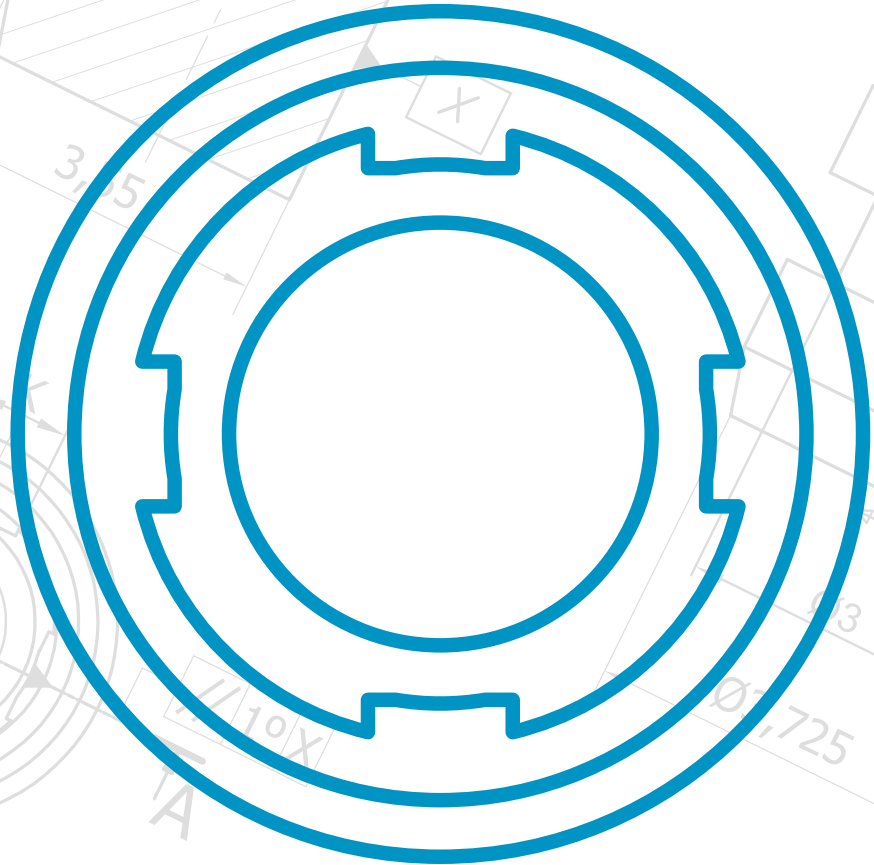

Screw Torx®



more alternatives in the special design screws section

DESS
prosthetic platform
Straumann® Bone level
equivalent prosthetic platform

NP	RP	NP/RP
NC/3.3	RC/4.1	NC/RC

19.032	19.033	19.037
19.032-P10	19.033-P10	19.037-P10
19.632	19.633	

Pack of 10

TIN coated

ON ABUTMENT SRA

Pack of 10

TIN coated

19.098
19.098-P10
19.698

Analogue



14.043	14.044
14.043-P10	14.044-P10

SRA

NEW



GH

14.098

Our analogues are suitable for both 3D and traditional models.

Ti base



NEW

NEW

NEW

1,2mm

3,0mm

1,2mm

3,0mm

SRA



15.043	15.044
15.343	15.344
16.043	16.044
16.343	16.344

15.098

16.098

Ti base Castables



Pack of 5

32.001-P5	32.001-P5
33.001-P5	33.001-P5

CoCr base



ON ABUTMENT SRA

DESS CoCr Ingots

1kg

CRCO1000

30.043	30.044
31.043	31.044
30.098	30.098
31.098	31.098

AURUMBase®

NP	RP
NC/3.3	RC/4.1



Torx® Screw

19.443	19.443
--------	--------



DESS
AURUMBase®

36.043	36.044
37.043	37.044



Plastic sleeves for
AURUMBase®

Pack of 5

0°

33.100-P5	33.100-P5
-----------	-----------

Pack of 5

10°

33.101-P5	33.101-P5
-----------	-----------

Pack of 5

20°

33.102-P5	33.102-P5
-----------	-----------

Torx® ball Screwdriver

20 mm

DT20TB06

24 mm

DT24TB06

35 mm

DT35TB06



spherical head for angulated screw channels up to 25°

Up to 25°
Angulated
Screw
Channel



Castable	DESS prosthetic platform Straumann® Bone level equivalent prosthetic platform	NP	RP	NP/RP
		NC/3.3	RC/4.1	NC/RC
	●	28.043	28.044	
	Pack of 10	11.043-P10	11.044-P10	
	●	29.043	29.044	
	Pack of 10	12.043-P10	12.044-P10	

Transfer			
		17.046	17.047

Temporary abutments			
	●	24.043	24.044
	●	25.043	25.044
	●	24.098	
		25.098	

Abutments			
	Straight	13.043	13.044
	Angled 15°	22.043	22.044

Healing abutment			
	3,0mm	20.041/3	20.042/3
	4,0mm	20.041/4	20.042/4
	5,0mm	20.041/5	20.042/5

DESSLoc®			
	1,0mm		88.042/1
	2,0mm	88.041/2	88.042/2
	3,0mm	88.041/3	88.042/3
	4,0mm	88.041/4	88.042/4

To see all the DESSLoc® available please refer to page 110

Scan abutments			
	for desktop scanning * use indicated screw	50.043 * 19.032	50.044 * 19.033
	for intra-oral scanning	52.043	52.044
	ON ABUTMENT SRA for desktop scanning * use indicated screw		50.098 * 19.098
	for intra-oral scanning		52.098
	on Ti base	53.100-P10	53.100-P10
	Pack of 10	53.200-P10	53.200-P10

All abutments include final screw, except castables in packs of 10 and scan abutments for desktop scanning.

● non-engaging ● engaging

Pre-milled blank	DESS prosthetic platform Straumann® Bone level equivalent prosthetic platform	NP	RP
		NC/3.3	RC/4.1
	Ti	61.043	61.044
	●	62.043	62.044
	CoCr	71.043	71.044

To see all the Pre-milled blank available please refer to page 116

Multiunit abutments	MULTI-UNIT PLATFORM 4.8			
		Straight	1,5mm ●	40.043/1
2,5mm ●			40.043/2	40.044/2
3,5mm ●			40.043/3	40.044/3
4,5mm ●				40.044/4
	Angled 17°	2,5mm ●	41.743/2	41.744/2
		3,5mm ●	41.743/3	41.744/3
		30°	43.043/3	43.044/3
		4,5mm ●	43.043/4	43.044/4

To see all the Multiunit abutments available please refer to page 104

Special Design Screws

Fits Straumann® Bone level implants and similar implant systems

Our Ref.	Plat.	A	B	C	D	E	F	G	H	I	
19.041	NC/RC	★	2,20	45°		4,50	1,60	0,30	2,60	M1,4	Standard screw
19.104*	NC/RC	★	2,10	0°	0,70	8,15	1,55	4,60	2,00	M1,6	Flat seat screw. Better for bridges, structures and zirconia abutments, ever without threaded hole.
19.105*	NC/RC	★	2,20	0°		4,50	1,50	0,00	3,00	M1,4	Flat seat screw. Better for bridges and structures
19.311	NC/RC	★	2,30	0°		8,10	1,50	4,00	2,70	M1,6	Special screw head design Torx® for angulated screw channels up to 25°

*Available also in pack of 10

★ Torx®

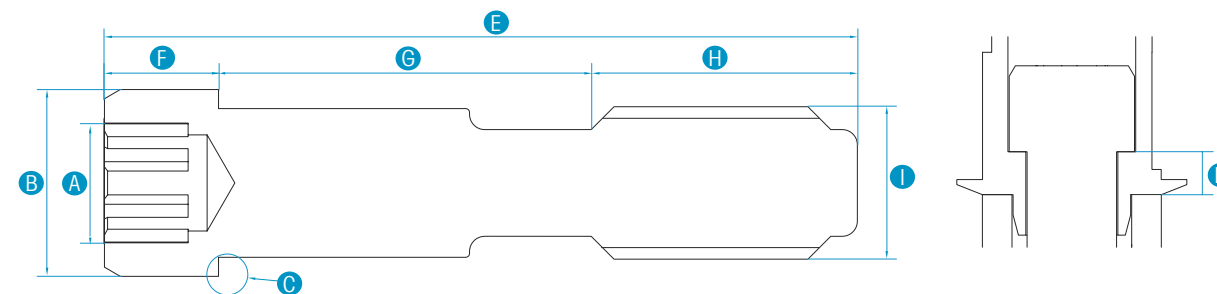

All abutments include final screw, except castables in packs of 10 and scan abutments for desktop scanning

INTERNAL HEX USA

compatible with
Zimmer® Screw-Vent

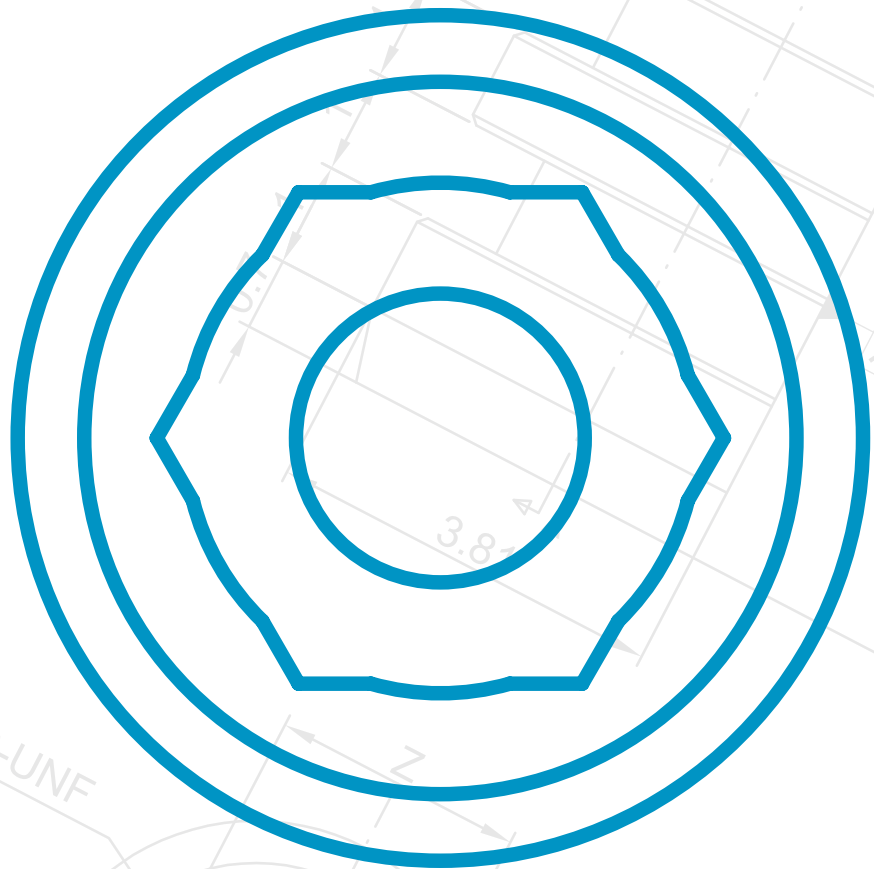

Screw hex



1,27mm

more alternatives in the special design screws section

Pack of 10

DESS
prosthetic platform
Zimmer® Screw-Vent
equivalent prosthetic platform

	NP	RP	WP
	GREEN 3.5	PURPLE 4.5	YELLOW 5.7

19.012	19.012	19.012
19.012-P10	19.012-P10	19.012-P10

Analogue



Pack of 10

14.017	14.018	14.019
14.017-P10	14.018-P10	

Our analogues are suitable for both 3D and traditional models.

Ti base



GH

0,3mm	●		15.018	15.019
0,8mm	●	15.017		
1,5mm	●	15.217	15.218	15.219
3,0mm	●	15.317	15.318	15.319
0,3mm	●		16.018	16.019
0,8mm	●	16.017		
1,5mm	●	16.217	16.218	16.219
3,0mm	●	16.317	16.318	16.319

Ti base Castables



Pack of 5

32.001-P5	32.001-P5	32.001-P5
33.001-P5	33.001-P5	33.001-P5

CoCr base



30.017	30.018	30.019
31.017	31.018	31.019

DESS CoCr Ingots



1kg CRC01000

AURUMBase®

	NP	RP	WP
	GREEN 3.5	PURPLE 4.5	YELLOW 5.7



Torx® Screw

19.417	19.417	19.417
--------	--------	--------

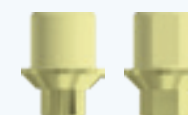

DESS
AURUMBase®

●	36.017	36.018	36.019
●	37.017	37.018	37.019



Plastic sleeves for
AURUMBase®

Pack of 5	0°	33.100-P5	33.100-P5
Pack of 5	10°	33.101-P5	33.101-P5
Pack of 5	20°	33.102-P5	33.102-P5

Torx® ball Screwdriver	20 mm DT20TB06	24 mm DT24TB06	35 mm DT35TB06
------------------------	-------------------	-------------------	-------------------



spherical head for angulated screw channels up to 25°

Up to 25°
Angulated
Screw
Channel



Castable	DESS prosthetic platform Zimmer® Screw-Vent equivalent prosthetic platform	NP	RP	WP
		GREEN 3.5	PURPLE 4.5	YELLOW 5.7
	●	28.017	28.018	28.019
	Pack of 10	11.017-P10	11.018-P10	
	●	29.017	29.018	29.019
	Pack of 10	12.017-P10	12.018-P10	

Transfer				
		17.017	17.018	17.019

Temporary abutments				
	●	24.017	24.018	24.019
	●	25.017	25.018	25.019

Abutments				
	Straight	13.017	13.018	13.019
	Angled 15°	22.017	22.018	22.019
	Angled 25°	23.017	23.018	

Healing abutment				
	3,0mm	20.017/3	20.018/3	20.019/3
	4,0mm	20.017/4	20.018/4	20.019/4
	5,0mm	20.017/5	20.018/5	20.019/5

DESSLoc®				
	1,0mm	88.017/1	88.018/1	
	2,5mm	88.017/2	88.018/2	
	3,5mm	88.017/3	88.018/3	
	4,5mm	88.017/4	88.018/4	
	5,5mm	88.017/5		

Scan abutments				
	for desktop scanning * use indicated screw	50.017	50.018	50.019
		* 19.012	* 19.012	* 19.012
●	for intra-oral scanning	52.017	52.018	52.019
	on Ti base	53.100-P10	53.100-P10	53.100-P10
●	Pack of 10	53.200-P10	53.200-P10	53.200-P10

● non-engaging ● engaging

All abutments include final screw, except castables in packs of 10 and scan abutments for desktop scanning.

Pre-milled blank	DESS prosthetic platform Zimmer® Screw-Vent equivalent prosthetic platform	NP	RP	WP
		GREEN 3.5	PURPLE 4.5	YELLOW 5.7
	Ti	61.017	61.018	61.019
	●	62.017	62.018	62.019
	CoCr	71.017	71.018	71.019

To see all the Pre-milled blank available please refer to page 116

Multiunit abutments				MULTI-UNIT PLATFORM 4.8	
	Straight	1,0mm ●	40.019/1	40.020/1	
		2,0mm ●	40.019/2	40.020/2	
		3,0mm ●	40.019/3	40.020/3	
		4,0mm ●	40.019/4		
		5,0mm ●	40.019/5		
	Angled 17°	2,5mm ●	41.719/2		
		3,5mm ●	41.719/3		
		30°			
	30°	3,5mm ●	43.019/3		
		4,5mm ●	43.019/4		

To see all the Multiunit abutments available please refer to page 104

Angled Multiunits include DLC SCREW.

Special Design Screws

Fits Zimmer® implants and similar implant systems

Our Ref.	Plat.	A	B	C	D	E	F	G	H	I	
19.012L	all	●	2,30	19°		8,95	2,55	3,80	2,60	UNF-1-72	Use with DESS abutments. Long version
19.042*	all	●	1,95	19°		8,20	2,49	2,95	2,76	UNF-1-72	Narrow head fits Zimmer® original abutments
19.312	all	★	2,40	0°		7,10	1,50	1,30	2,70	UNF-1-72	Special screw head design Torx® for angulated screw channels up to 25°
19.110	RP(4,8)	●	2,00	0°		2,80	3,45	1,35	0,00	M1,4	ON IMPLANT FOR MULTI-UNIT®
19.642	all	●	1,95	19°		8,20	2,49	2,95	2,76	UNF-1-72	TIN

*Available also in pack of 10

★ Torx® ● H1,27

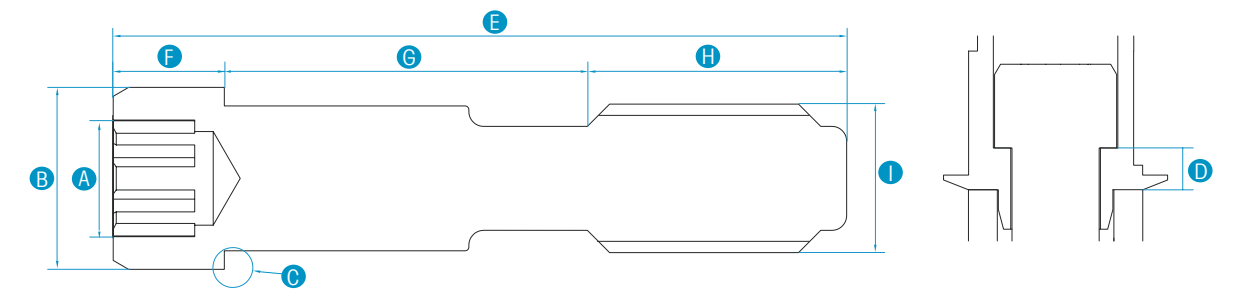

CONIC EVO

compatible with

Astra Tech implant system™ EV

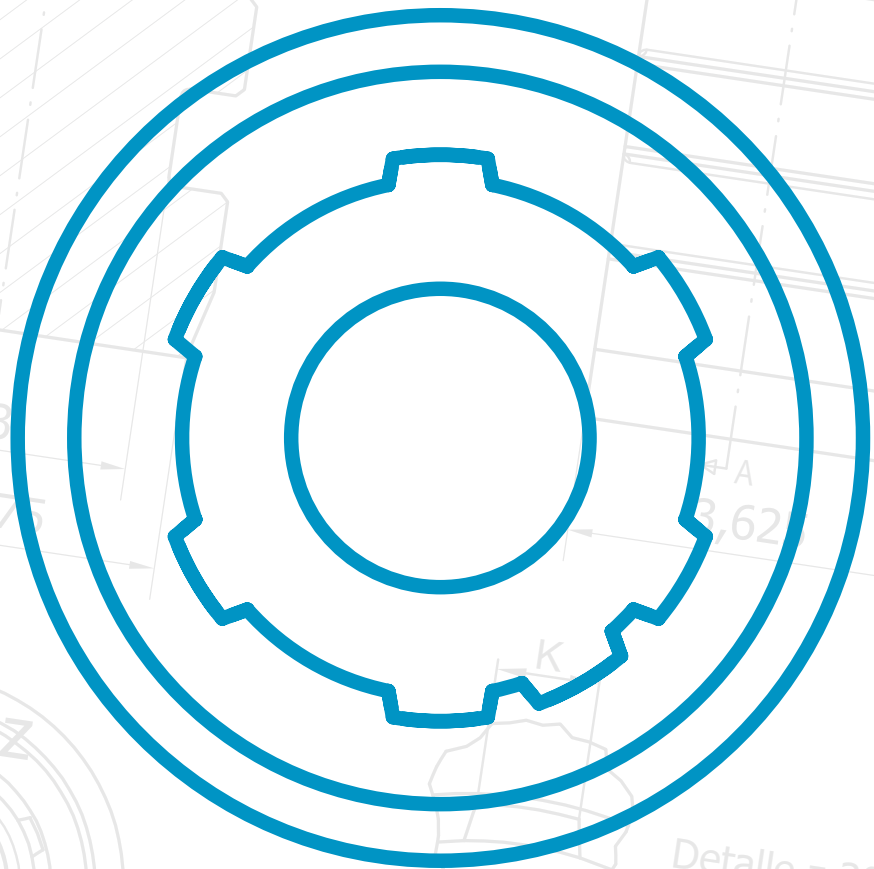

Detalle z 30 : 1

Screw hex

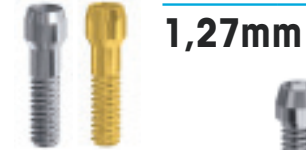

1,27mm

DESS
prosthetic platform
Astra Tech implant system™ EV
equivalent prosthetic platform

EV/3.6 EV/4.2 EV/4.8

	PURPLE 3.6	YELLOW 4.2	BLUE 4.8
	19.059	19.060	19.061
	19.659	19.660	19.661

NEW TIN coated

ON UNIABUTMENT®

19.058

NEW TIN coated

19.658

Analogue



NEW
COLORS

OF UNIABUTMENT®

14.058

Our analogues are suitable for both 3D and traditional models.

Ti base



	1,0mm	●	15.059	15.060	15.061
NEW	3,0mm	●	15.359	15.360	15.361
	1,0mm	●	16.059	16.060	16.061
NEW	3,0mm	●	16.359	16.360	16.361

ON UNIABUTMENT®

Ti base Castables

15.058

Pack of 5	●	32.001-P5	32.001-P5	32.001-P5
ON UNIABUTMENT®	●	33.001-P5	33.001-P5	33.001-P5
Pack of 5	●	32.001-P5		

CoCr base



	●	30.059	30.060	30.061
	●	31.059	31.060	31.061

ON UNIABUTMENT®

30.058

DESS CoCr Ingots

1kg CRC01000

AURUMBase®

EV/3.6 EV/4.2 EV/4.8

PURPLE
3.6 YELLOW
4.2 BLUE
4.8



Torx® Screw

19.441 19.460 19.461



DESS
AURUMBase®

● 36.059 36.060 36.061
● 37.059 37.060 37.061



Plastic sleeves for
AURUMBase®

Pack of 5	0°	33.100-P5	33.100-P5	33.100-P5
Pack of 5	10°	33.101-P5	33.101-P5	33.101-P5
Pack of 5	20°	33.102-P5	33.102-P5	33.102-P5



Torx® ball Screwdriver

20 mm DT20TB06 24 mm DT24TB06 35 mm DT35TB06

spherical head for angulated screw channels up to 25°

Up to 25°
Angulated
Screw
Channel



Castable

DESS
prosthetic platform
Astra Tech implant system™ EV
equivalent prosthetic platform

EV/3.6 EV/4.2 EV/4.8

PURPLE 3.6 YELLOW 4.2 BLUE 4.8



		28.059	28.060	28.061
ON UNIABUTMENT®				
	28.058			

Transfer



		17.059	17.060	17.061
ON UNIABUTMENT®				
	17.058			

Temporary abutments



		24.059	24.060	24.061
		25.059	25.060	25.061
ON UNIABUTMENT®				
	24.058			

Healing abutment



3,5mm	ø4 20.059/3	ø5 20.060/3	ø5 20.061/3
4,5mm	ø4 20.059/4	ø5 20.060/4	ø6,5 20.061/4
6,5mm	ø4 20.059/6	ø5 20.060/6	ø6,5 20.061/6

DESSLoc®



1,0mm	88.059/1	88.060/1	88.061/1
2,0mm	88.059/2	88.060/2	88.061/2
3,0mm	88.059/3	88.060/3	88.061/3
4,0mm	88.059/4	88.060/4	88.061/4

To see all the DESSLoc® available please refer to page 110

Scan abutments



for desktop scanning <i>* use indicated screw</i>	50.059	50.060	50.061
	* 19.059	* 19.060	* 19.061

ON UNIABUTMENT®			
	50.058		
	* 19.058		

NEW for intra-oral scanning	52.059	52.060	52.061
------------------------------------	--------	--------	--------

ON UNIABUTMENT®			
	52.058		

NEW on Ti base			
Pack of 10	53.100-P10	53.100-P10	53.100-P10
	53.200-P10	53.200-P10	53.200-P10

Pre-milled blank



Ti	DESS prosthetic platform Astra Tech implant system™ EV equivalent prosthetic platform	EV/3.6 PURPLE 3.6	EV/4.2 YELLOW 4.2	EV/4.8 BLUE 4.8
	ø10mm	61.059	61.060	61.061
	NEW ø14mm	62.059	62.060	62.061
CoCr	ø14mm	71.059	71.060	71.061

To see all the Pre-milled blank available please refer to page 116

UniAbutment®



UniAbutment need a
1,7mm hex screwdriver

1,0mm	40.059/1	40.060/1	40.061/1
2,0mm	40.059/2	40.060/2	40.061/2
3,0mm	40.059/3	40.060/3	40.061/3
5,0mm	40.059/5	40.060/5	40.061/5

All abutments include final screw. Transfers include two screws (for open and closed tray).

● non-engaging ● engaging

NEW Ti-Base Scan Abutment

To be used on Ti-bases and AURUMBase®, the new scan abutment offers you total flexibility with the same scanning precision you are used to, from other DESS® scan abutments.

Advantages of the new scan abutment:

- Available for more than 27 different implant connections
- Reusable
- Free*

Compatible with most of DESS® Ti-bases, the same scan abutment can be used in more than 99 different Ti-bases including AURUMbase® allowing you to re-use it several times.

*The scan abutment file can be downloaded from our website and printed in a 3d printer



INTERNAL HEX CONIC

compatible with

Astra Tech Osseospeed™



Screw hex

1,27mm



DESS
prosthetic platform
Astra Tech Osseospeed™
equivalent prosthetic platform

NP
YELLOW
3.0

RP
AQUA
3.5-4.0

WP
LILAC
4.5-5.0

Pack of 10	19.015	19.016	19.017
Tin coated	19.615	19.616	19.617
ON UNIABUTMENT®			
	19.018		
Pack of 10	19.018-P10		
Tin coated	19.618		

Analogue

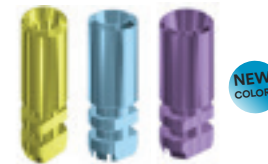

OF UNIABUTMENT®		14.023	14.024	14.025
20°			14.024-P10	14.025-P10
Pack of 10	14.036			
45°	14.037			
Pack of 10	14.037-P10			

Our analogues are suitable for both 3D and traditional models.

Ti base



0,9mm	●			15.025
1,0mm	●	15.023		
1,1mm	●		15.024	
NEW 3,0mm	●	15.324	15.325	
0,9mm	●			16.025
1,0mm	●	16.023		
1,1mm	●		16.024	
NEW 3,0mm	●	16.324	16.325	
ON UNIABUTMENT®				
20°	●	15.036		
45°	●	15.037		

Ti base Castables



		32.001-P5	32.001-P5	32.001-P5
ON UNIABUTMENT®		33.001-P5	33.001-P5	33.001-P5
		32.001-P5		

AURUMBase®



Torx® Screw

RP
AQUA
3.5-4.0

WP
LILAC
4.5-5.0

19.441

19.425



DESS
AURUMBase®

●

●

36.024

36.025

37.024

37.025



Plastic sleeves for
AURUMBase®

Pack of 5	0°	33.100-P5	33.100-P5
Pack of 5	10°	33.101-P5	33.101-P5
Pack of 5	20°	33.102-P5	33.102-P5



Torx® ball Screwdriver

20 mm DT20TB06

24 mm DT24TB06

35 mm DT35TB06

spherical head for angulated screw channels up to 25°

Up to 25°
Angulated
Screw
Channel



CoCr base

DESS
prosthetic platform
Astra Tech Osseospeed™
equivalent prosthetic platform

NP RP WP
YELLOW 3.0 AQUA 3.5-4.0 LILAC 4.5-5.0



	●		30.024	30.025
	●		31.024	31.025

ON UNIABUTMENT®

20°	●	30.036
45°	●	30.037



DESS CoCr Ingots
1kg CRCO1000

Castable



	●		28.024	28.025
Pack of 10			11.024-P10	11.025-P10
	●		29.024	29.025
Pack of 10			12.024-P10	12.025-P10

ON UNIABUTMENT®

20°	●	28.036
Pack of 10		11.036-P10
45°	●	28.037
Pack of 10		11.037-P10

Transfer

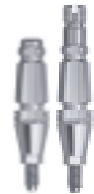

			17.024	17.025
	●			
OF UNIABUTMENT®				
20°	●	17.036		
45°	●	17.037		

Temporary abutments



	●		24.024	24.025
	●		25.024	25.025
	●			
ON UNIABUTMENT®				
20°	●	24.028		
45°	●	24.029		

Abutments



Straight			13.024	13.025
Angled	15°		22.024	22.025
	25°		23.024	

Healing abutment



		3,0mm	20.024/3	20.025/3
		4,0mm	20.024/4	20.025/4
		5,0mm	20.024/5	20.025/5

Anatomic healing abutment



Ø4,5	4,0mm	20.424/4	
Ø5,5	4,0mm	20.524/4	20.525/4
Ø6,5	4,0mm		20.625/4

DESSLoc®

DESS
prosthetic platform
Astra Tech Osseospeed™
equivalent prosthetic platform

NP RP WP
YELLOW 3.0 AQUA 3.5-4.0 LILAC 4.5-5.0



1mm		88.024/1	88.025/1
2mm		88.024/2	88.025/2
3mm		88.024/3	88.025/3
4mm		88.024/4	88.025/4

To see all the DESSLoc® available please refer to page 110

Scan abutments



for desktop scanning
* use indicated screw

ON UNIABUTMENT®

20°	50.036	50.024	50.025
	* 19.018	* 19.016	* 19.017
45°	50.037		
	* 19.018		

NEW

for intra-oral scanning

ON UNIABUTMENT®

20°	52.036	52.024	52.025
45°	52.037		

NEW

on Ti base

Pack of 10	●	53.100-P10	53.100-P10	53.100-P10
	●	53.200-P10	53.200-P10	53.200-P10

Pre-milled blank



Ti	●	Ø10mm	61.023	61.024	61.025
	NEW	Ø14mm		62.024	62.025
CoCr		Ø14mm		71.024	71.025

To see all the Pre-milled blank available please refer to page 116

UniAbutment®



20°	0,5mm	40.013/0	40.015/0
	1,0mm	40.013/1	40.015/1
	2,0mm	40.013/2	40.015/2
	4,0mm	40.013/4	40.015/4
	6,0mm	40.013/6	40.015/6
45°	0,5mm	40.014/0	40.016/0
	1,0mm	40.014/1	40.016/1
	2,0mm	40.014/2	40.016/2
	4,0mm	40.014/4	40.016/4
	6,0mm	40.014/6	40.016/6

● non-engaging

● engaging

All abutments include final screw, except castables in packs of 10 and scan abutments for desktop scanning.

INTERNAL HEX FD

compatible with

Xive®

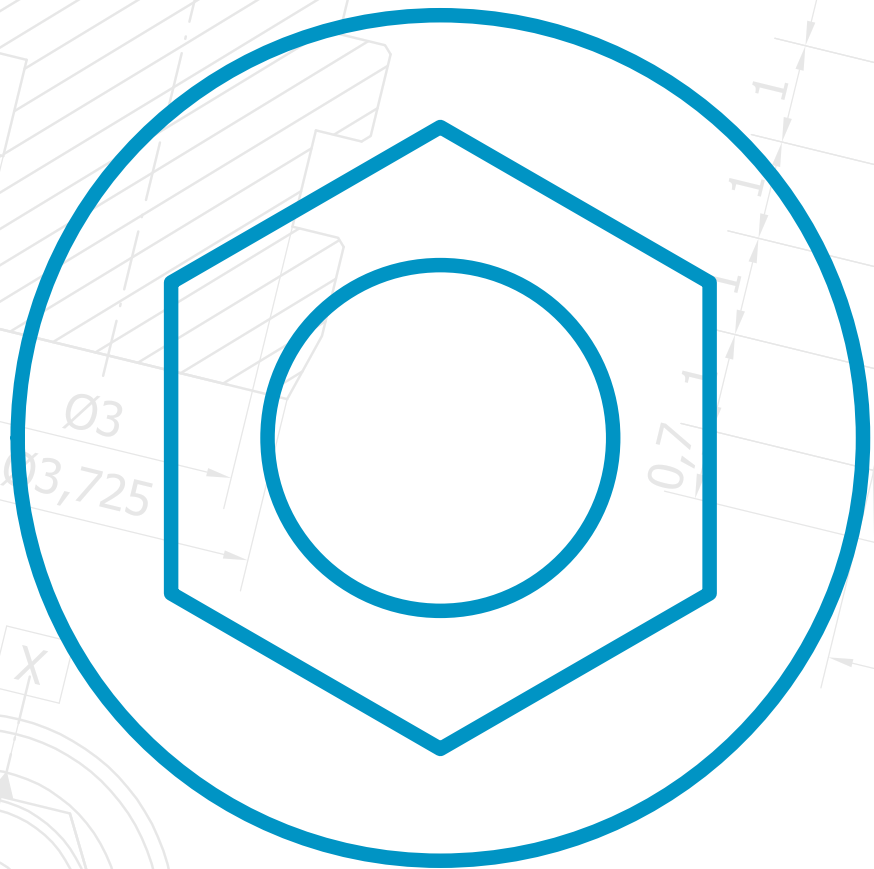

Screw hex



DESS
prosthetic platform
Xive®
equivalent prosthetic platform

	NP	RP	WP	5.5
	SILVER 3.4	YELLOW 3.8	BLUE 4.5	RED 5.5

Pack of 10

19.024	19.024	19.024	19.024
19.024-P10	19.024-P10	19.024-P10	19.024-P10

NEW
TIN coated

19.624	19.624	19.624	19.624
--------	--------	--------	--------

Analogue

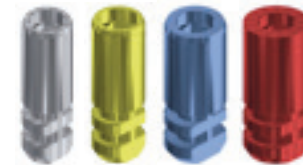

NEW
COLORS

Pack of 10

14.038	14.039	14.040	14.071
	14.039-P10		

Our analogues are suitable for both 3D and traditional models.

Ti base



GH

0,3mm	●	15.038	15.039	15.040	15.071
1,5mm	●	15.238	15.239	15.240	15.271
3,0mm	●	15.338	15.339	15.340	15.371
0,3mm	●	16.038	16.039	16.040	16.071
1,5mm	●	16.238	16.239	16.240	16.271
3,0mm	●	16.338	16.339	16.340	16.371

Ti base Castables



Pack of 5

●	32.001-P5	32.001-P5	32.001-P5	32.001-P5
●	33.001-P5	33.001-P5	33.001-P5	33.001-P5

CoCr base



DESS CoCr Ingots

1kg

CRC01000

●	30.038	30.039	30.040
●	31.038	31.039	31.040

AURUMBase®

	NP	RP	WP
	SILVER 3.4	YELLOW 3.8	BLUE 4.5



Torx® Screw

19.438	19.438	19.438
--------	--------	--------



DESS
AURUMBase®

●	36.038	36.039	36.040
●	37.038	37.039	37.040



Plastic sleeves for
AURUMBase®

Pack of 5	0°	33.100-P5	33.100-P5
Pack of 5	10°	33.101-P5	33.101-P5
Pack of 5	20°	33.102-P5	33.102-P5

Torx® ball Screwdriver

20 mm

DT20TB06

24 mm

DT24TB06

35 mm

DT35TB06

spherical head for angulated screw channels up to 25°

Up to 25°
Angulated
Screw
Channel



Castable

DESS
prosthetic platform
Xive®
equivalent prosthetic platform

	NP	RP	WP	5.5
	SILVER 3.4	YELLOW 3.8	BLUE 4.5	RED 5.5

●		28.038	28.039	28.040
	Pack of 10		11.039-P10	
◆		29.038	29.039	29.040
	Pack of 10		12.039-P10	

Transfer

	17.038	17.039	17.040
--	--------	--------	--------



Temporary abutments

●	24.038	24.039	24.040
◆	25.038	25.039	25.040

Abutments

Straight	13.038	13.039	13.040
Angled 15°	22.038	22.039	22.040
	23.039		
Angled 25°			



Healing abutment

3,0mm	20.036/3	20.037/3	20.038/3
4,0mm	20.036/4	20.037/4	20.038/4
5,0mm	20.036/5	20.037/5	20.038/5

DESSLoc®

1,0mm	88.036/1	88.037/1
2,0mm	88.036/2	88.037/2
3,0mm	88.036/3	88.037/3
4,0mm	88.036/4	88.037/4

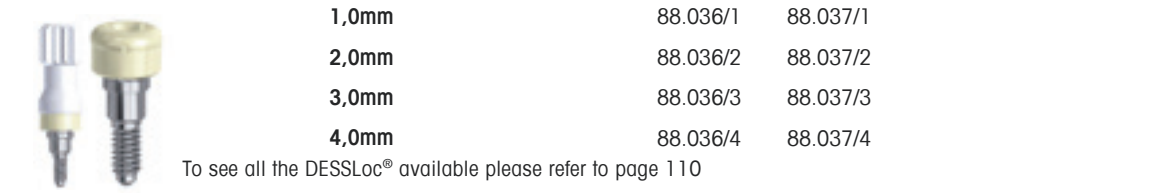

Scan abutments

for desktop scanning * use indicated screw	50.038 * 19.024	50.039 * 19.024	50.040 * 19.024	50.071 * 19.024
for intra-oral scanning	52.038	52.039	52.040	52.071
on Ti base				
●	53.100-P10	53.100-P10	53.100-P10	53.100-P10
◆	53.200-P10	53.200-P10	53.200-P10	53.200-P10



Pre-milled blank

DESS
prosthetic platform
Xive®
equivalent prosthetic platform

	NP	RP	WP	5.5
	SILVER 3.4	YELLOW 3.8	BLUE 4.5	RED 5.5

Ti	∅10mm	61.038	61.039	61.040	61.071
	∅14mm		62.039	62.040	62.071
CoCr	∅14mm	71.038	71.039	71.040	71.071

To see all the Pre-milled blank available please refer to page 116

All abutments include final screw. Transfers include two screws (for open and closed tray).

● non-engaging ◆ engaging

**YOUR DESIGN
OUR PRECISION**

Mill your design with the precision of the DESS® connections.
Our range of Blank premills are available for more than 19 different connections.



INTERNAL ANK

compatible with

Dentsply Ankylos® C/X



Screw hex

Dentsply Ankylos® C/X
equivalent prosthetic platform



1,00mm

more alternatives in the special design screws section

Pack of 10
NEW TIN coated

height:

1,5mm	19.048
	19.048-P10
	19.648
2,5mm	19.050

Analogue



Pack of 10

Pack of 10

Ø 3,5	14.048
	14.048-P10
Ø 4,5	14.049
	14.049-P10

Our analogues are suitable for both 3D and traditional models.

Ti base



GH

1,5mm	●	15.050
NEW 2,5mm	●	15.250
1,5mm	○	16.050
NEW 2,5mm	○	16.250

Ti base Castables



●	32.001-P5
○	33.001-P5

CoCr base



height:

1,5mm	●	30.050
2,5mm	●	30.250
1,5mm	○	31.050
2,5mm	○	31.250

DESS CoCr Ingots



1kg CRCO1000

Castable



height:

1,5mm	●	28.048
2,5mm	●	28.250

Transfer



height:

1,5mm	○	17.049
2,5mm	○	17.250

All abutments include final screw. Transfers include two screws (for open and closed tray).

● non-engaging

○ engaging

Temporary abutments



		height:		
		1,5mm	●	24.048
		2,5mm	●	24.250
		1,5mm	○	25.048
		2,5mm	○	25.250

Abutments



		height:		
Straight		1,5mm	○	13.047
		2,5mm	○	13.250
15° Angled		1,5mm	○	22.048
		2,5mm	○	22.250
25° Angled		1,5mm	○	23.048
		2,5mm	○	23.250

Healing abutment



		height:	
		1,5mm	20.046/1
		2,5mm	20.046/3

DESSLoc®



		height:	
		2,0mm	88.046/2
		3,0mm	88.046/3
		4,0mm	88.046/4

To see all the DESSLoc® available please refer to page 110

Scan abutments



	for desktop scanning <i>* use indicated screw</i>	50.049
		* 19.048
NEW	for intra-oral scanning	52.049
NEW	on Ti base	53.100-P10
	Pack of 10	53.200-P10

Pre-milled blank



Ti	∅10mm	61.250
CoCr	∅14mm	71.250

To see all the Pre-milled blank available please refer to page 116

Special Design Screws

Fits Dentsply Ankylos® C/X implants and similar implant systems

Our Ref. Plat. A B C D E F G H I



19.349	★	2,40	0°	5,00	1,50	0,00	2,75	M1,6	Special screw head design Torx® for angulated screw channels up to 25°. On Ankylos® abutment.
--------	---	------	----	------	------	------	------	------	-----------------------------------------------------------------------------------------------

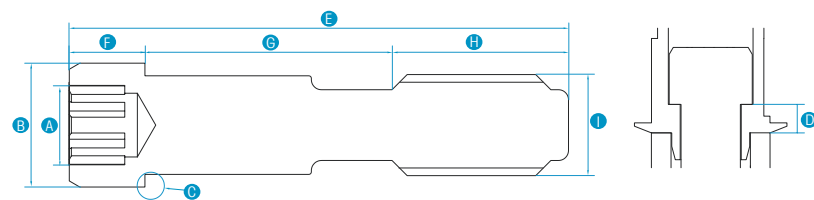

★ Torx®

DESSLoc®

Superior resistance, better results

Coated with a Zirconium nitride (ZrN), the DESSLoc® overdenture anchor system offers you better resistance with less plaque adhesion improving results and reducing inflammation

- 100% compatible with the most popular system
- Reduces plaque adhesion
- Decreases inflammation

DESSLoc® coated with Zirconium nitride:

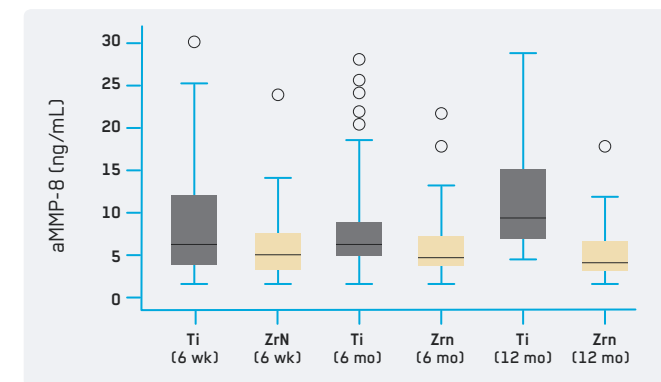

aMMP-8 values of fluid from peri-implant sulcus in titanium (Ti) and Zirconium Nitride (ZrN) coated attachments at different times after prosthetic restoration. (Matrix Metalloproteinase-8 Levels in Peri-implant Sulcus Fluid Adjacent to Titanium and Zirconium Nitride Surface, Richard Meissen, MSc1 Mariana Mintcheva, MSc1 Lutz Netuschil, PhD Dr2, Int J Periodontics Restorative Dent 2014; 34:91-95. doi: 10.11607/prd.1504)



Please see the full range of DESSLoc® abutments available from page 110

CONIC OSS

compatible with
Osstem® TS

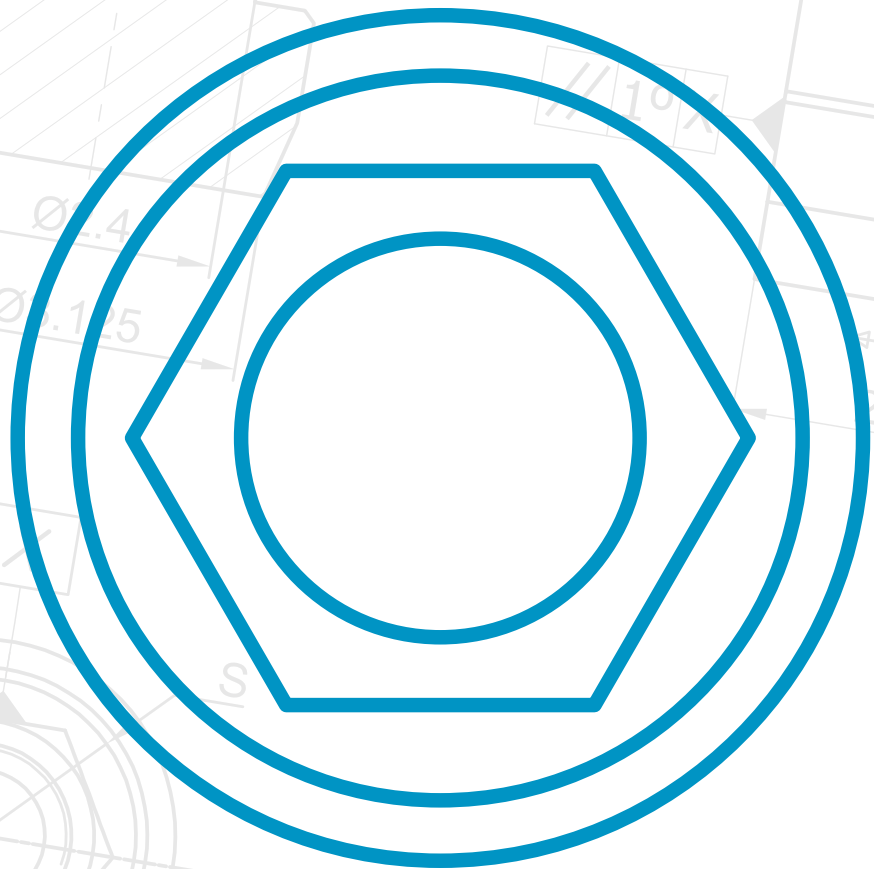

Screw hex



1,22mm

NEW

DESS
prosthetic platform
Osstem® TS
equivalent prosthetic platform

MINI STD
YELLOW MINI GREEN REGULAR

19.072	19.073
19.272	19.273
19.672	19.673

Analogue



14.072	14.073
--------	--------

Our analogues are suitable for both 3D and traditional models.

Ti base



GH

1,0mm	●	15.072	15.073
3,0mm	●	15.372	15.373
1,0mm	●	16.072	16.073
3,0mm	●	16.372	16.373

Ti base Castables



Pack of 5

●	32.001-P5	32.001-P5
●	33.001-P5	33.001-P5

Scan abutments



for desktop scanning
* use indicated screw

50.072	50.073
* 19.072	* 19.073

for intra-oral scanning

52.072	52.073
--------	--------

on Ti base

Pack of 10

●	53.100-P10	53.100-P10
●	53.200-P10	53.200-P10

Pre-milled blank



Ti	∅10mm	61.072	61.073
	∅14mm	62.072	62.073
CoCr	∅14mm	71.072	71.073

To see all the Pre-milled blank available please refer to page 116

AURUMBase®

MINI STD
YELLOW MINI GREEN REGULAR



Torx® Screw

19.444	19.461
--------	--------



DESS
AURUMBase®

●	36.072	36.073
●	37.072	37.073



Plastic sleeves for
AURUMBase®

Pack of 5	0°	33.100-P5	33.100-P5
Pack of 5	10°	33.101-P5	33.101-P5
Pack of 5	20°	33.102-P5	33.102-P5



Torx® ball Screwdriver

20 mm	24 mm	35 mm
DT20TB06	DT24TB06	DT35TB06

spherical head for angulated screw channels up to 25°

Up to 25°
Angulated
Screw
Channel



All abutments include final screw. Transfers include two screws (for open and closed tray).

● non-engaging

● engaging

INTERNAL CAM

compatible with
Camlog®

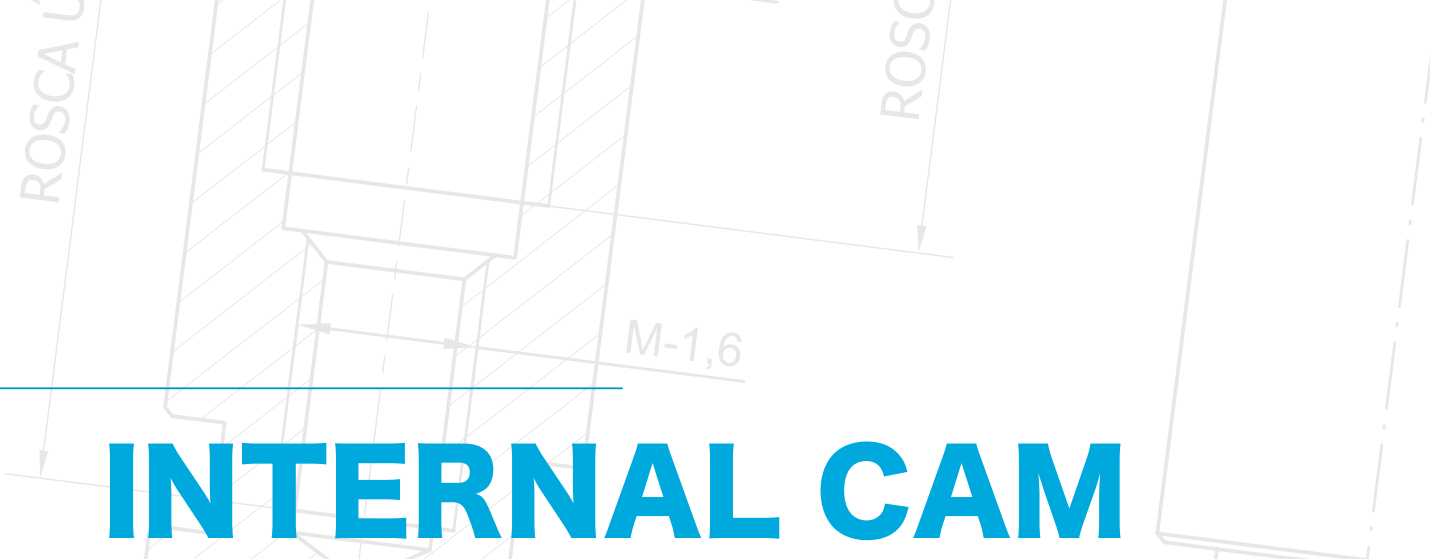
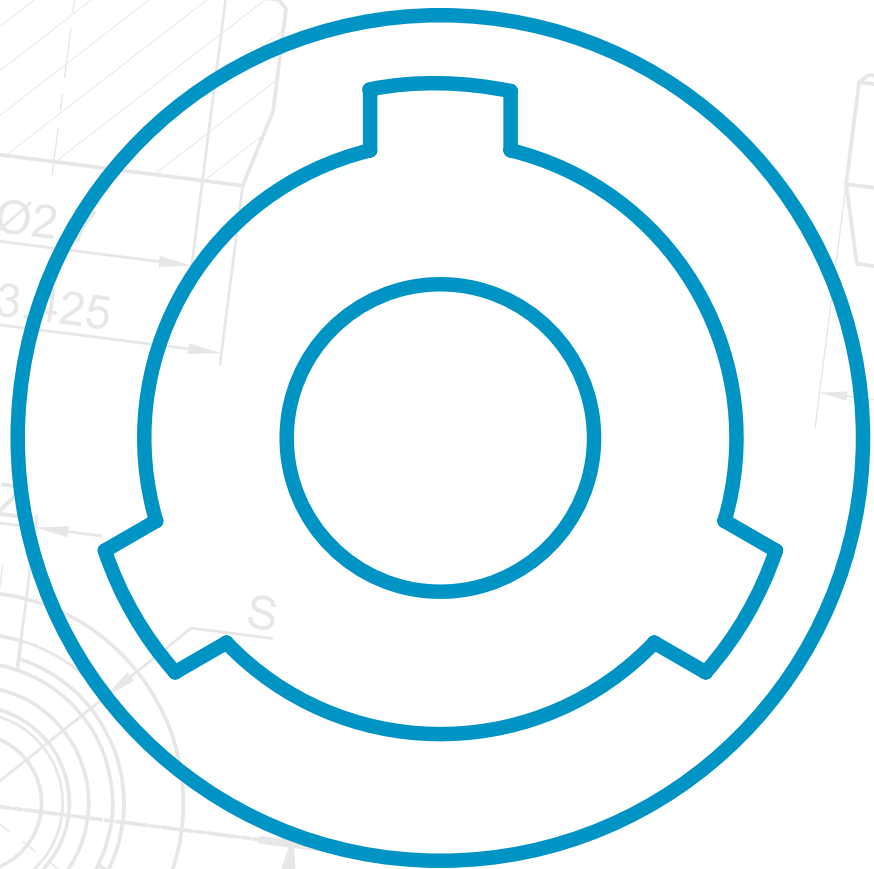

DESS
prosthetic platform
Camlog®
equivalent prosthetic platform

3.3 3.8 4.3 5.0
SILVER 3.3 YELLOW 3.8 PINK 4.3 BLUE 5.0

Screw hex



1,27mm

more alternatives in the special design screws section

NEW TIN coated

19.044	19.044	19.044	19.045
19.644	19.644	19.644	19.645

Analogue

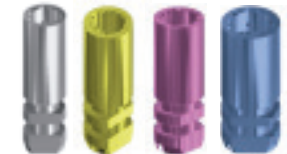

NEW COLORS

14.064	14.065	14.066	14.067
--------	--------	--------	--------

Our analogues are suitable for both 3D and traditional models.

Ti base



GH

0,3mm	●		15.065	15.066	15.067
0,5mm	●	15.064			
1,5mm	●		15.265	15.266	
3,0mm	●		15.365	15.366	
0,3mm	●		16.065	16.066	16.067
0,5mm	●	16.064			
1,5mm	●		16.265	16.266	
3,0mm	●		16.365	16.366	

Ti base Castables



Pack of 5

●	32.001-P5	32.001-P5	32.001-P5	32.001-P5
●	33.001-P5	33.001-P5	33.001-P5	33.001-P5

CoCr base



●		30.065	30.066
●		31.065	31.066

DESS CoCr Ingots



1kg CRC01000

AURUMBase®

3.8 4.3
YELLOW 3.8 PINK 4.3



Torx® Screw

19.444	19.444
--------	--------



DESS
AURUMBase®

●	36.065	36.066
●	37.065	37.066



Plastic sleeves for
AURUMBase®

Pack of 5	0°	33.100-P5	33.100-P5
Pack of 5	10°	33.101-P5	33.101-P5
Pack of 5	20°	33.102-P5	33.102-P5

Torx® ball Screwdriver 20 mm DT20TB06 24 mm DT24TB06 35 mm DT35TB06



spherical head for angulated screw channels up to 25°

Up to 25°
Angulated
Screw
Channel



Castable	DESS prosthetic platform	3.3	3.8	4.3	5.0
	Camlog® equivalent prosthetic platform	SILVER 3.3	YELLOW 3.8	PINK 4.3	BLUE 5.0



●	28.065	28.066
---	--------	--------

Transfer		17.065	17.066
-----------------	--	--------	--------



Temporary abutments	●	24.065	24.066
	◆	25.065	25.066



Healing abutment	3,0mm	20.065/3	20.066/3
	4,0mm	20.065/4	20.066/4
	5,0mm	20.065/5	20.066/5



DESSLoc®	1,0mm	88.065/1	88.066/1
	2,0mm	88.065/2	88.066/2
	3,0mm	88.065/3	88.066/3
	4,0mm	88.065/4	88.066/4



To see all the DESSLoc® available please refer to page 110

Scan abutments	for desktop scanning <i>* use indicated screw</i>	50.064	50.065	50.066	50.067
		* 19.044	* 19.044	* 19.044	* 19.045



for intra-oral scanning		52.064	52.065	52.066	52.067
	on Ti base				
	●	53.100-P10	53.100-P10	53.100-P10	53.100-P10
	◆	53.200-P10	53.200-P10	53.200-P10	53.200-P10

NEW

Pack of 10

Pre-milled blank	DESS prosthetic platform	3.3	3.8	4.3	5.0
	Camlog® equivalent prosthetic platform	SILVER 3.3	YELLOW 3.8	PINK 4.3	BLUE 5.0



Ti	∅10mm	61.064	61.065	61.066	61.067
	NEW ∅14mm		62.065	62.066	62.067
CoCr	∅14mm	71.064	71.065	71.066	71.067

To see all the Pre-milled blank available please refer to page 116

All abutments include final screw. Transfers include two screws (for open and closed tray).

● non-engaging ● engaging

THE DEFINITIVE MULTI-UNIT ABUTMENT

Full thread in the connection cone means a safer and more stable prosthesis

The vertical access of the screw facilitates the placement of it. It also allows you to tight it at maximum torque of 35Ncm* avoiding loosening and improving the stability of the Multi-Unit abutment.

*According to compatibility

Multiple gingival heights

Full shaped connection provides more stability.

The DESS® Ti Base for Multi-Unit® is available in two different heights: 6mm and 8mm.

DESS > DENTAL SMART SOLUTIONS

NEW
COMPATIBILITY

INTERNAL CON

compatible with
Conelog®

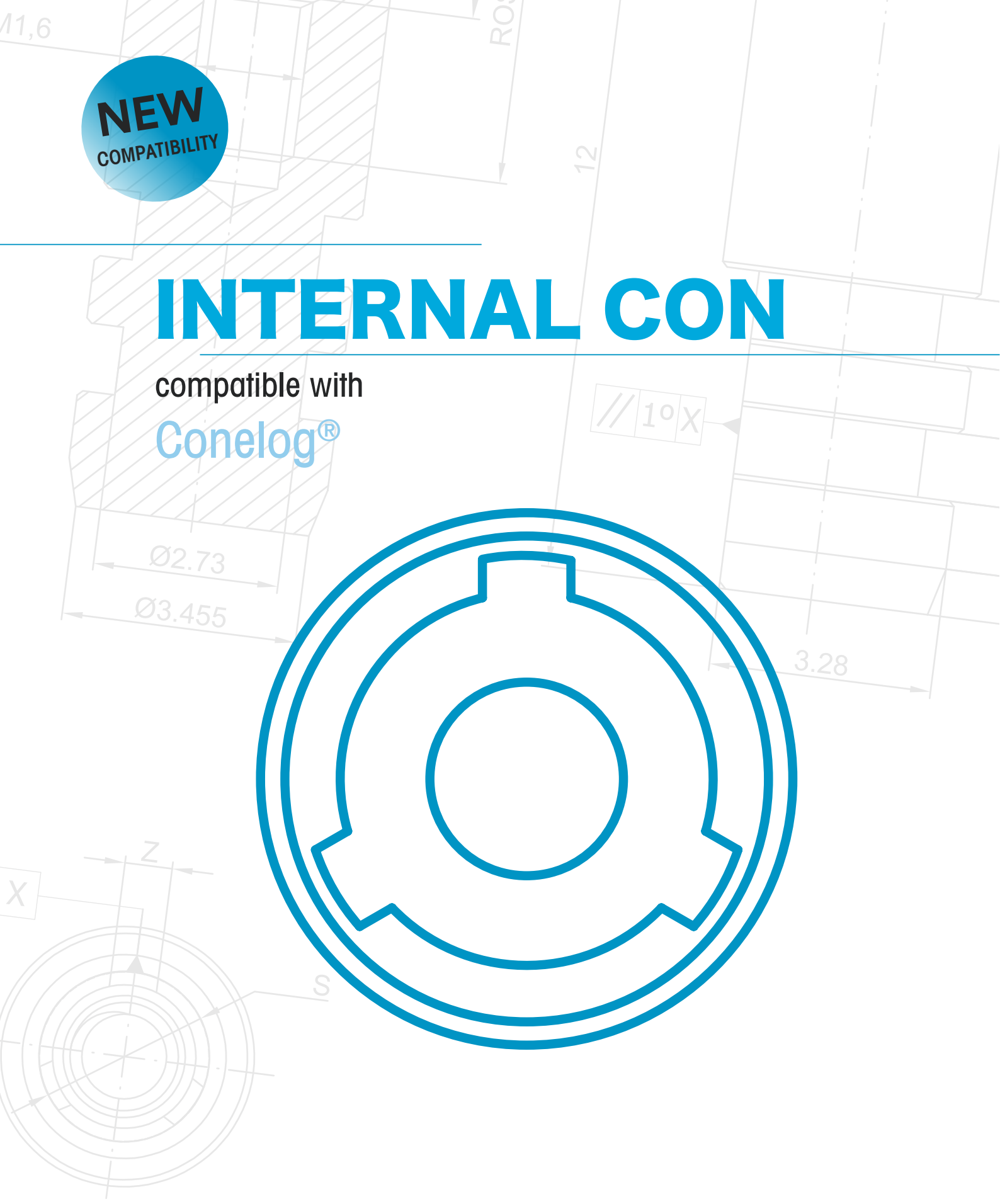
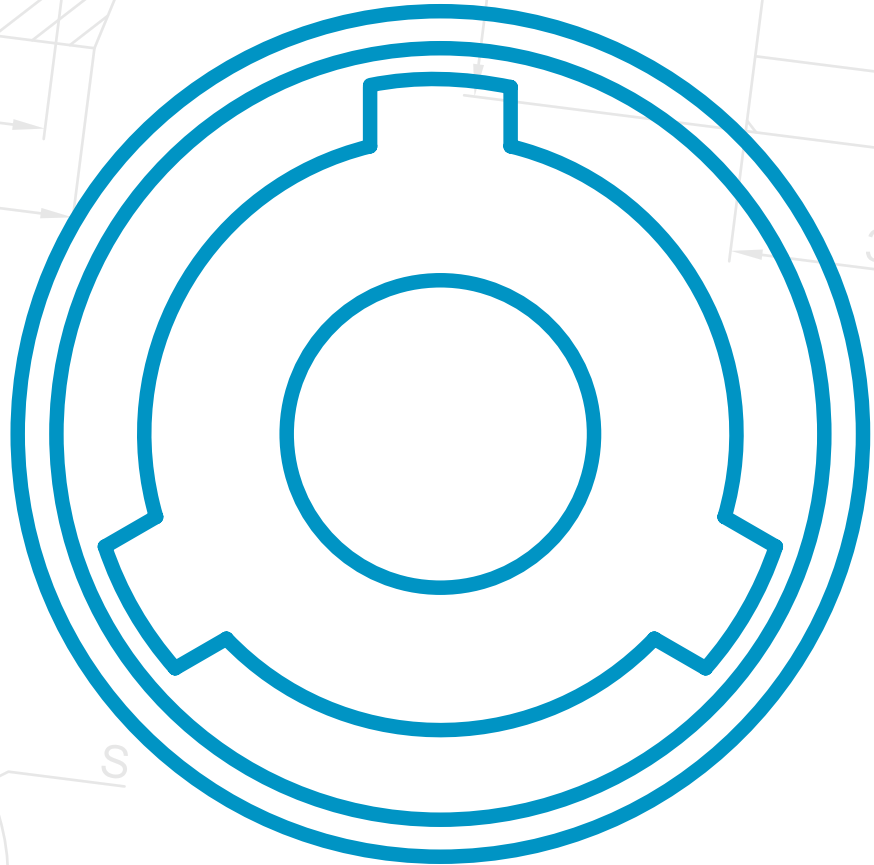

Screw hex 1,27mm	DESS prosthetic platform	NP	RP	WP
	Conelog® equivalent prosthetic platform	3.3	3.8	5.0
	TIN coated	19.074	19.074	19.076
		19.674	19.674	19.676

Analogue	NP	RP	WP
	14.074	14.075	14.076

Our analogues are suitable for both 3D and traditional models.

Ti base	GH				
		1,4 mm	●	15.074	15.075
	1,4 mm	●	16.074	16.075	16.076
Ti base Castables	Pack of 5				
		●	32.001-P5	32.001-P5	32.001-P5
	●	32.001-P5	32.001-P5	32.001-P5	

Scan abutments	for intra-oral scanning				
				52.074	52.075
on Ti base	Pack of 10				
		●	53.100-P10	53.100-P10	53.100-P10
	●	53.200-P10	53.200-P10	53.200-P10	

Pre-milled blank					
		Ti	∅10mm	61.074	61.075
		∅14mm	62.074	62.075	62.076
	CoCr	∅14mm	71.074	71.075	71.076

To see all the Pre-milled blank available please refer to page 116

All abutments include final screw. Transfers include two screws (for open and closed tray).

● non-engaging ● engaging

INTERNAL HEX BH

compatible with
Biohorizons® internal



Screw hex 1,27mm



DESS
prosthetic platform
Biohorizons® internal
equivalent prosthetic platform

NP	RP	WP
YELLOW 3.5	GREEN 4.5	BLUE 5.7

TIN coated

19.043	19.043	19.043
19.643	19.643	19.643

Analogue

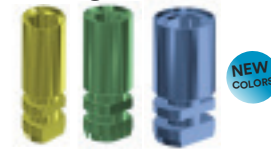

14.087	14.088	14.089
--------	--------	--------

Our analogues are suitable for both 3D and traditional models.

Ti base



GH

0,3 mm	●	15.088	15.089
0,8 mm	●	15.087	
0,3 mm	●	16.088	16.089
0,8 mm	●	16.087	

Ti base Castables



Pack of 5	●	32.001-P5	32.001-P5	32.001-P5
	●	33.001-P5	33.001-P5	33.001-P5

Healing abutment



3,0mm	20.017/3	20.018/3	20.019/3
4,0mm	20.017/4	20.018/4	20.019/4
5,0mm	20.017/5	20.018/5	20.019/5

DESSLoc®



1,0mm	88.017/1	88.018/1
2,5mm	88.017/2	88.018/2
3,5mm	88.017/3	88.018/3
4,5mm	88.017/4	88.018/4
5,5mm	88.017/5	

To see all the DESSLoc® available please refer to page 110

Multiunit abutments

MULTI-UNIT PLATFORM
4.8



Straight	1,0mm	●	40.019/1	40.020/1
	2,0mm	●	40.019/2	40.020/2
	3,0mm	●	40.019/3	40.020/3
	4,0mm	●	40.019/4	
	5,0mm	●	40.019/5	

Scan abutments



for intra-oral scanning	52.087	52.088	52.089
-------------------------	--------	--------	--------

on Ti base	Pack of 10	●	53.100-P10	53.100-P10	53.100-P10
		●	53.200-P10	53.200-P10	53.200-P10

EXTERNAL HEX BH

compatible with
BioHorizons® External



Screw hex



1,27mm

more alternatives in the special design screws section

Pack of 10
NEW TIN coated

DESS
prosthetic platform
BioHorizons® External
equivalent prosthetic platform

	NP	RP	WP
	YELLOW 3.7	GREEN 4.2	BLUE 5.2
	19.013	19.014	19.014
		19.014-P10	19.014-P10
	19.613	19.614	19.614

Analogue

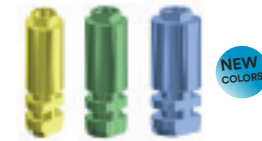

NEW COLORS

Pack of 10

	14.020	14.021	14.022
		14.021-P10	

Our analogues are suitable for both 3D and traditional models.

Ti base



GH

0,3mm



	15.051	15.052	15.053
--	--------	--------	--------

0,3mm



	16.051	16.052	16.053
--	--------	--------	--------

Ti base Castables



	32.001-P5	32.001-P5	32.003-P5
--	-----------	-----------	-----------



	33.001-P5	33.001-P5	33.003-P5
--	-----------	-----------	-----------

Castable



Pack of 10



	28.020	28.021	28.022
--	--------	--------	--------

11.021-P10

Pack of 10



	29.020	29.021	29.022
--	--------	--------	--------

12.021-P10

Transfer



	17.020	17.021	17.022
--	--------	--------	--------

Temporary abutments



	24.020	24.021	24.022
--	--------	--------	--------



	25.020	25.021	25.022
--	--------	--------	--------

Abutments



Straight

	13.020	13.021	13.022
--	--------	--------	--------

Angled

15°

	22.020	22.021	
--	--------	--------	--

Healing abutment



DESS
prosthetic platform
BioHorizons® External
equivalent prosthetic platform

	NP YELLOW 3.7	RP GREEN 4.2	WP BLUE 5.2
3 mm	20.020/3	20.021/3	20.022/3
4 mm	20.020/4	20.021/4	20.022/4
5 mm	20.020/5	20.021/5	20.022/5

Scan abutments



	NP	RP	WP
for desktop scanning <small>* use indicated screw</small>	50.020 <small>* 19.013</small>	50.021 <small>* 19.014</small>	50.022 <small>* 19.014</small>
for intra-oral scanning	52.020	52.021	52.022
on Ti base Pack of 10	53.100-P10	53.100-P10	53.100-P10
	53.200-P10	53.200-P10	53.200-P10

Pre-milled blank



	Ti	CoCr
Ø10mm	61.021	61.022
Ø14mm	71.021	71.022

To see all the Pre-milled blank available please refer to page 116

All abutments include final screw. Transfers include two screws (for open and closed tray).

● non-engaging ● engaging

Special Design Screws

Fits BioHorizons® implants and similar implant systems

Our Ref.	Plat.	A	B	C	D	E	F	G	H	I	
19.312	NP	★	2,40	0°		7,10	1,50	1,30	3,50	UNF-1-72	Special screw head design Torx® for angulated screw channels up to 25°
19.328	NP/WP	★	2,460	0°		7,60	1,50	2,10	4,00	M2,0	Special screw head design Torx® for angulated screw channels up to 25°

★ Torx®

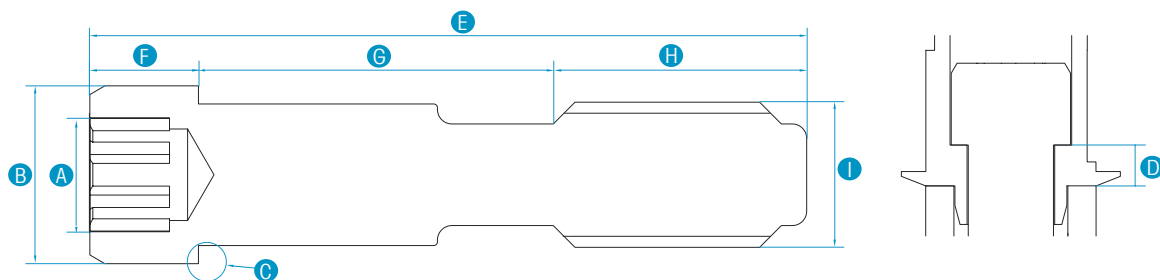

We are DESS®

DESS® offers a variety of dental prosthetic solutions for nearly all the connections available in the market. DESS® product quality is as good or better than the quality of well-known brands. The **“pure switch concept”** on which our products are conceived assure full compatibility with the implant brand chosen.



AURUMBase®
Screw channel solution
for up to 25° angle
entry point and 360°
rotation



Titanium Intraoral
Scan abutment for a
more precise image

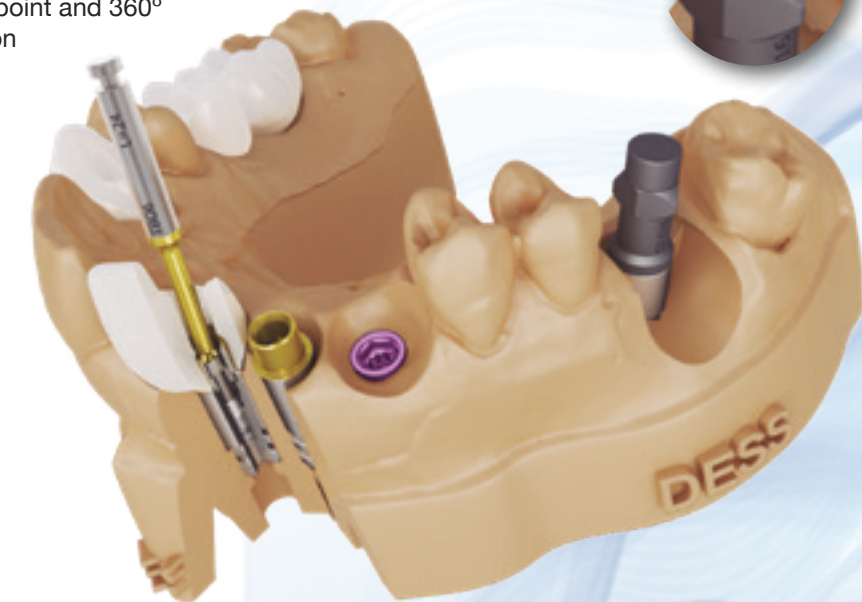

Titanium anodized
analogues, colour
coded to match the
original system

Reasons to switch to DESS®

- **One stop shop**
28 compatibilities with the most popular implant connections
- **Fast delivery**
24hr delivery
- **Competitive Prices**
Up to 65% below implant brands
- **European Quality**
ISO 9001, ISO 13485, CE, FDA, Health Canada
- **Lifetime Warranty**
All DESS® manufactured products have a lifetime warranty

INTERNAL HEX MI

compatible with
MIS® SEVEN

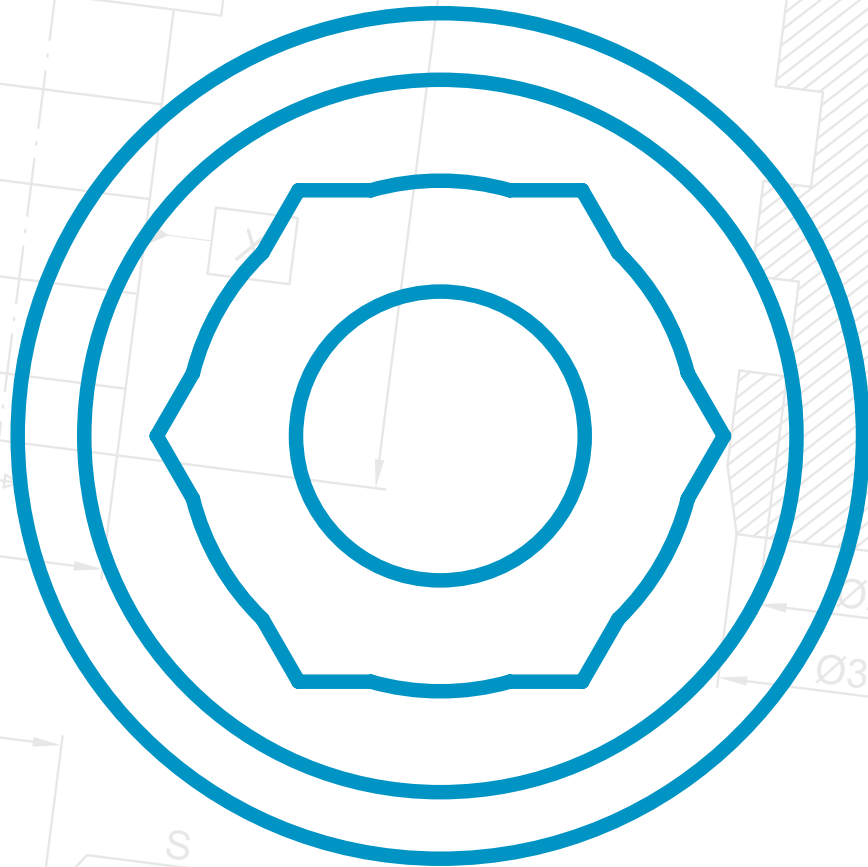

M1,6

Ø2.5

Ø3.12

// 1° X

Screw hex



1,27mm

more alternatives in the special design screws section

NEW Pack of 10
TIN coated

DESS
prosthetic platform
MIS® SEVEN
equivalent prosthetic platform

	NP YELLOW NARROW	SP PURPLE STANDARD	WP GREEN WIDE	MULTIUNIT 4.8
	19.056	19.081	19.081	19.110
				19.085
	19.656	19.681	19.681	19.685

Analogue



Pack of 10

14.056	14.095	14.096	14.007
			14.085
	14.095-P10	14.096-P10	14.007-P10

Our analogues are suitable for both 3D and traditional models.

Ti base



GH

0,3mm	●			15.096
0,8mm	●	15.056	15.095	
1,5mm	●		15.295	15.296
3,0mm	●		15.395	15.396
0,3mm	●			16.096
0,8mm	●	16.056	16.095	
1,5mm	●		16.295	16.296
3,0mm	●		16.395	16.396

Ti base Castables



Pack of 5

●	32.001-P5	32.001-P5	32.001-P5
●	33.001-P5	33.001-P5	33.001-P5

CoCr base



●	30.056	30.095	30.096
●	31.056	31.095	31.096

DESS CoCr Ingots



1kg CRC01000

AURUMBase®



Torx® Screw

	SP PURPLE STANDARD	WP GREEN WIDE
	19.417	19.417

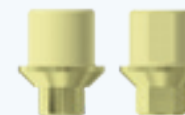

DESS
AURUMBase®

●	36.017	36.018
●	37.017	37.018



Plastic sleeves for
AURUMBase®

Pack of 5	0°	33.100-P5	33.100-P5
Pack of 5	10°	33.101-P5	33.101-P5
Pack of 5	20°	33.102-P5	33.102-P5

Torx® ball Screwdriver 20 mm DT20TB06 24 mm DT24TB06 35 mm DT35TB06



spherical head for angulated screw channels up to 25°

Up to 25°
Angulated
Screw
Channel



Castable

	DESS prosthetic platform MIS® SEVEN equivalent prosthetic platform	NP YELLOW NARROW	SP PURPLE STANDARD	WP GREEN WIDE
Pack of 10	●	28.056	28.095	28.096
			11.017-P10	11.018-P10
Pack of 10	●	29.056	29.095	29.096
			12.017-P10	12.018-P10

Transfer

		17.056	17.017	17.018
--	--	--------	--------	--------

Temporary abutments

	●		24.095	24.096
	●		25.095	25.096

Abutments

			13.095	13.096
	15°		22.095	22.096
	25°		23.095	23.096

Healing abutment

	3,0mm		20.017/3	20.018/3
	4,0mm		20.017/4	20.018/4
	5,0mm		20.017/5	20.018/5

DESSLoc®

	1,0mm		88.017/1	88.018/1
	2,5mm		88.017/2	88.018/2
	3,5mm		88.017/3	88.018/3
	4,5mm		88.017/4	88.018/4
	5,5mm		88.017/5	

Scan abutments

for desktop scanning <i>* use indicated screw</i>		50.056	50.017	50.018
		* 19.056	* 19.081	* 19.081
for intra-oral scanning		52.056	52.017	52.018
on Ti base Pack of 10	●	53.100-P10	53.100-P10	53.100-P10
	●	53.200-P10	53.200-P10	53.200-P10

All abutments include final screw, except castables in packs of 10 and scan abutments for desktop scanning.

● non-engaging ● engaging

Pre-milled blank

	DESS prosthetic platform MIS® SEVEN equivalent prosthetic platform	NP YELLOW NARROW	SP PURPLE STANDARD	WP GREEN WIDE
Ti	ø10mm		61.095	61.096
CoCr	ø14mm		71.095	71.096

To see all the Pre-milled blank available please refer to page 116

Multunit abutments

		DESS > DENTAL SMART SOLUTIONS		MULTI-UNIT PLATFORM 4, 8	
with DLC screw	Straight	1,0mm ●		40.019/1	40.020/1
		2,0mm ●		40.019/2	40.020/2
		3,0mm ●		40.019/3	40.020/3
		4,0mm ●		40.019/4	
		5,0mm ●		40.019/5	
17°	Angled 17°	2,5mm ●		41.719/2	
		3,5mm ●		41.719/3	
30°	Angled 30°	3,5mm ●		43.019/3	
		4,5mm ●		43.019/4	

Special Design Screws

Fits MIS® implants and similar implant systems

Our Ref.	Plat.	A	B	C	D	E	F	G	H	I	
19.312	all	★	2,40	0°		7,10	1,50	1,30	2,70	UNF-1-72	Special screw head design Torx® for angulated screw channels up to 25°
ON IMPLANT FOR MULTI-UNIT® 19.110	RP(4,8)	●	2,00	0°	2,80	3,45	1,35	0,00	2,10	M1,4	
ON IMPLANT FOR MULTI-UNIT® 19.300	RP(4,8)	★	2,15	0°		3,95	1,50	0,50	1,95	UNF-1-72	Special screw head design Torx® for angulated screw channels up to 25°

★ Torx® ● H1,27

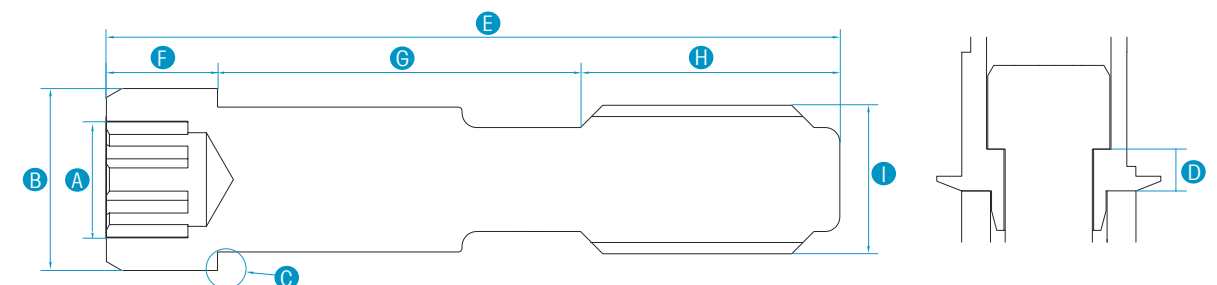

NEW
COMPATIBILITY

CONIC MC

compatible with
MIS® C1 internal

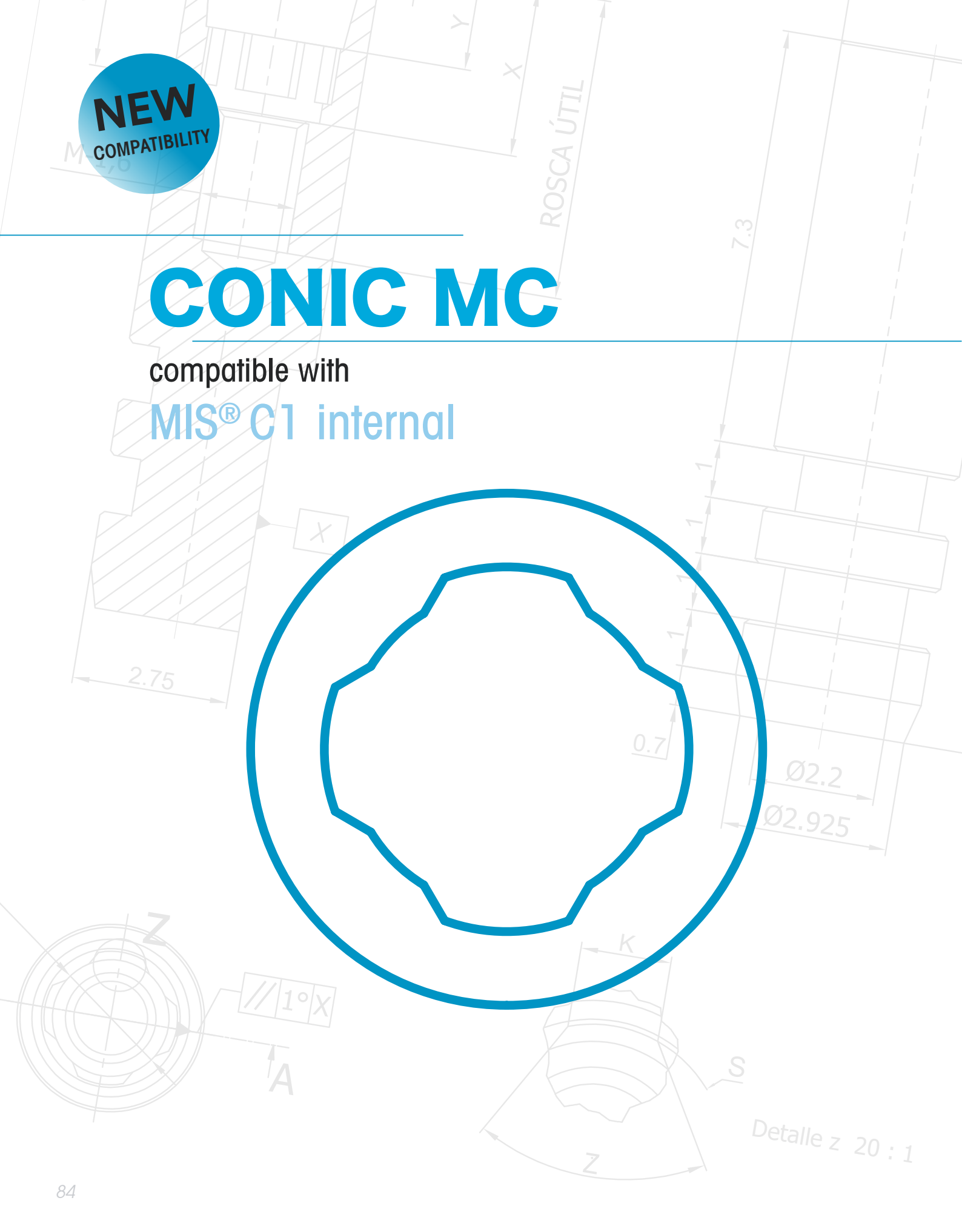
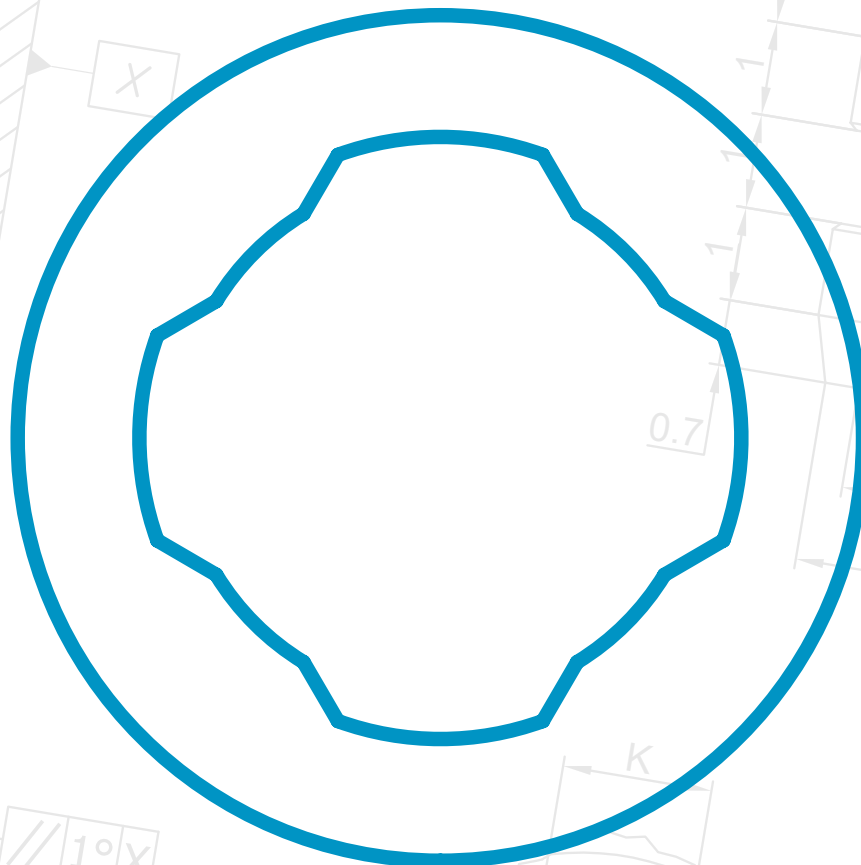

DESS prosthetic platform MIS® C1 internal equivalent prosthetic platform	NP	SP	WP	MULTIUNIT
	YELLOW	PURPLE	GREEN	4.8
Screw hex 1,27mm	19.081	19.056	19.081	19.085 MIS
TIN coated	19.681	19.656	19.681	19.685 MIS

Analogue	NP	SP	WP	MULTIUNIT
	14.081	14.082	14.083	14.085 MIS

Our analogues are suitable for both 3D and traditional models.

Ti base	GH			
	0,3mm	●		15.085 MIS
	1,0mm	●	15.081	15.082
	1,0mm	●	16.081	16.082

Ti base Castables	Pack of 5			
	●	32.001-P5	32.001-P5	32.001-P5
	●	33.001-P5	33.001-P5	33.001-P5

Scan abutments	for intra-oral scanning			
		52.081	52.082	52.083
on Ti base	Pack of 10	●	53.100-P10	53.100-P10
		●	53.200-P10	53.200-P10

All abutments include final screw. Transfers include two screws (for open and closed tray).

● non-engaging ● engaging

NEW
COMPATIBILITY

CONIC MV

compatible with
MIS® V3



	DESS prosthetic platform MIS® V3 equivalent prosthetic platform	NP BLUE	SP PURPLE	MULTIUNIT 4.8
Screw hex 1,27mm		19.056	19.081	19.085 MIS
	TIN coated	19.656	19.681	19.685 MIS



Analogue



	14.084	14.082	14.085 MIS
Our analogues are suitable for both 3D and traditional models.			

Ti base



	GH		
0,3mm	●		15.085 MIS
1,0mm	●	15.084	15.082
1,0mm	●	16.084	16.082

Ti base Castables



Pack of 5	●	32.001-P5	32.001-P5	32.007-P5
	●	33.001-P5	33.001-P5	

Scan abutments



for intra-oral scanning		52.084	52.082
on Ti base			
Pack of 10	●	53.100-P10	53.100-P10
	●	53.200-P10	53.200-P10

All abutments include final screw. Transfers include two screws (for open and closed tray).

● non-engaging ● engaging

CONIC ANYR

compatible with
MEGAGEN AnyRidge®

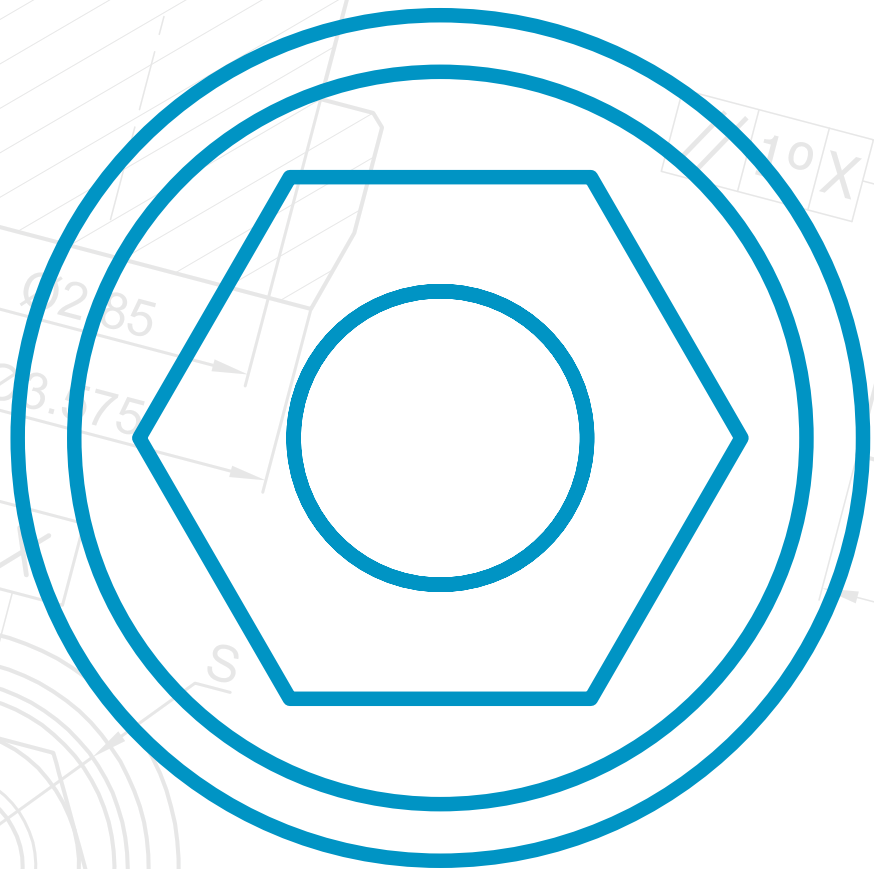

Screw hex

MEGAGEN AnyRidge®
equivalent prosthetic platform



1,20mm

TIN coated

19.057

19.657

Analogue



NEW
COLOR

14.057

Our analogues are suitable for both 3D and traditional models.

Ti base



GH

2,0mm



15.057

3,0mm



15.357

2,0mm



16.057

3,0mm



16.357

Ti base Castables



Pack of 5



32.001-P5



33.001-P5

Scan abutments



for desktop scanning

* use indicated screw

50.057

* 19.057

for intra-oral scanning

52.057

on Ti base

Pack of 10



53.100-P10



53.200-P10

Pre-milled blank



Ti

ø10mm

61.057

CoCr

ø14mm

71.057

To see all the Pre-milled blank available please refer to page 116

AURUMBase®



Torx® Screw

19.460



DESS
AURUMBase®



36.057



37.057



Plastic sleeves for
AURUMBase®

Pack of 5

0°

33.100-P5

Pack of 5

10°

33.101-P5

Pack of 5

20°

33.102-P5

Torx® ball Screwdriver

20 mm

DT20TB06

24 mm

DT24TB06

35 mm

DT35TB06



spherical head for angulated screw channels up to 25°



All abutments include final screw. Transfers include two screws (for open and closed tray).

● non-engaging

● engaging

CONIC AXIO

compatible with
Anthogyr AXIOM®



Screw hex

Anthogyr AXIOM®
equivalent prosthetic platform



1,18mm

TIN coated



ON ABUTMENT®

TIN coated

Analogue



Our analogues are suitable for both 3D and traditional models.

Ti base



GH

2,9 mm



15.077

2,9 mm



16.077

Ti base Castables



32.001-P5



33.001-P5

Scan abutments

for intra-oral scanning

52.077



on Ti base

Pack of 10



53.100-P10



53.200-P10

All abutments include final screw. Transfers include two screws (for open and closed tray).

● non-engaging

● engaging

CONIC IC

compatible with
Medentis ICX®



Screw hex

Medentis ICX®
equivalent prosthetic platform



1,40mm

NEW TIN coated

19.080
19.680

Analogue



14.080

Our analogues are suitable for both 3D and traditional models.

Ti base

GH



2,2 mm



15.080

2,2 mm



16.080

Ti base Castables



Pack of 5



32.001-P5



32.001-P5

Scan abutments



for desktop scanning
* use indicated screw

50.080
* 19.080

for intra-oral scanning

52.080

NEW on Ti base

Pack of 10



53.100-P10



53.200-P10

Pre-milled blank



Ti

NEW

CoCr

ø10mm

61.080

ø14mm

62.080

ø14mm

71.080

AURUMBase®



Torx® Screw

2,2 mm

19.444

0,9 mm

19.443



DESS
AURUMBase®

2,2 mm



36.080

0,9 mm



36.180

2,2 mm



37.080

0,9 mm



37.180



Plastic sleeves for
AURUMBase®

Pack of 5

0°

33.100-P5

Pack of 5

10°

33.101-P5

Pack of 5

20°

33.102-P5



Torx® ball Screwdriver

20 mm

24 mm

35 mm

DT20TB06

DT24TB06

DT35TB06

spherical head for angulated screw channels up to 25°



All abutments include final screw. Transfers include two screws (for open and closed tray).

● non-engaging

● engaging

CONIC INK

compatible with
GlobalID IN-KONE®



Screw hex

GlobalID IN-KONE®
equivalent prosthetic platform



1,22mm

19.086

19.686

Analogue



14.086

Our analogues are suitable for both 3D and traditional models.

Ti base



GH

1,5 mm



15.086

1,5 mm



16.086

Ti base Castables

Pack of 5



32.001-P5



33.001-P5

Scan abutments



for intra-oral scanning

52.086

on Ti base
Pack of 10



53.100-P10



53.200-P10

All abutments include final screw. Transfers include two screws (for open and closed tray).

non-engaging

engaging

CONIC DENT

compatible with

Dentium Superline™ & Implantium®



Screw hex



1,28mm

DESS
prosthetic platform
Dentium Superline™ & Implantium®
equivalent prosthetic platform

RP / YELLOW / GREEN / BLUE / RED
3.8 3.6 4.0 4.5 5.0

NEW TIN coated

19.090

19.690

Analogue



ON ABUTMENT

TIN coated

19.066

19.666

14.090

Our analogues are suitable for both 3D and traditional models.

Ti base



GH

0,9mm



15.090

0,9mm



16.090

Ti base Castables

Pack of 5



32.001-P5



33.001-P5

Scan abutments

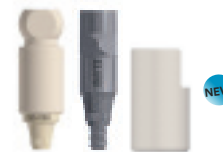

NEW

for desktop scanning

* use indicated screw

50.090

* 19.090

for intra-oral scanning

52.090

on Ti base

Pack of 10



53.100-P10



53.200-P10

Pre-milled blank



Ti

ø10mm

61.090

CoCr

ø14mm

71.090

To see all the Pre-milled blank available please refer to page 116

All abutments include final screw. Transfers include two screws (for open and closed tray).

non-engaging

engaging

INTERNAL SEM

compatible with

Bego Semados®

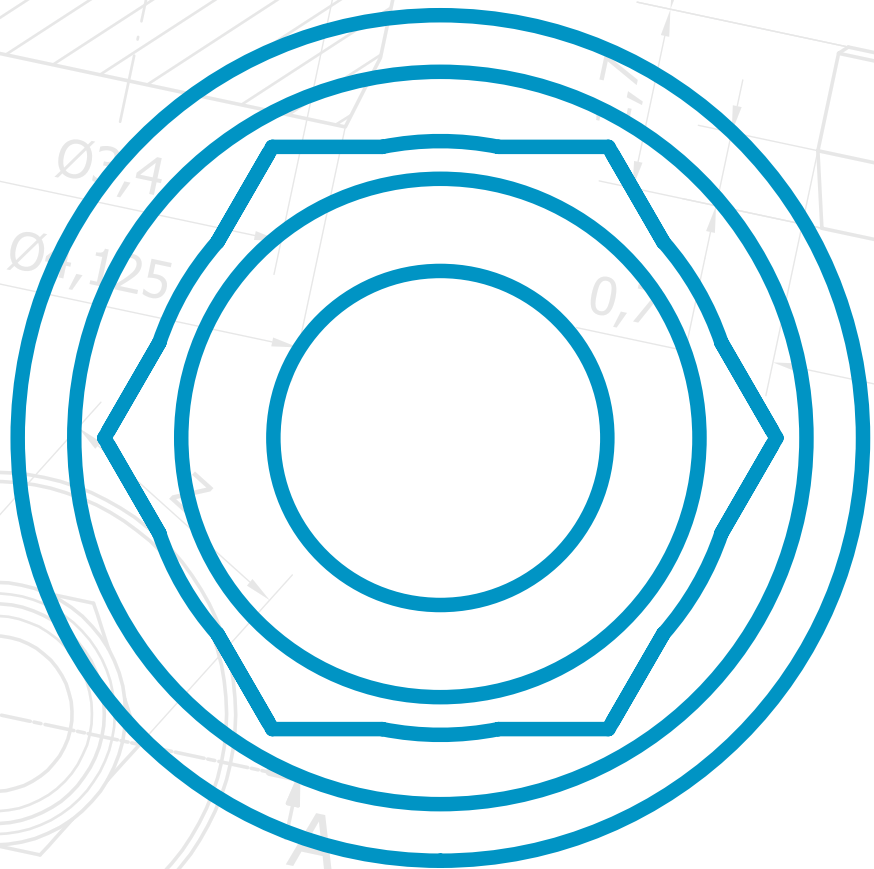

DESS
prosthetic platform
Bego Semados®
equivalent prosthetic platform

	3.25/3.75	4.1	4.5	5.5
Screw hex	GREEN/BLUE	SILVER	RED	YELLOW

1,27mm



NEW TIN coated

19.091	19.091	19.091	19.091
19.691	19.691	19.691	19.691

Analogue



14.091	14.092	14.093	14.094
--------	--------	--------	--------

Our analogues are suitable for both 3D and traditional models.

Ti base



GH

0,7mm	●		15.091	15.094
0,9mm	●		15.091	
1,1mm	●	15.091		
0,7mm	●		16.091	16.094
0,9mm	●		16.091	
1,1mm	●	16.091		

Ti base Castables

Pack of 5	●	32.001-P5	32.001-P5	32.001-P5	32.001-P5
	●	33.001-P5	33.001-P5	33.001-P5	33.001-P5

Scan abutments



for intra-oral scanning	52.091	52.092	52.093	52.094	
on Ti base	●	53.100-P10	53.100-P10	53.100-P10	53.100-P10
Pack of 10	●	53.200-P10	53.200-P10	53.200-P10	53.200-P10

All abutments include final screw. Transfers include two screws (for open and closed tray).

● non-engaging

● engaging

NEW
COMPATIBILITY

CONIC BIO

compatible with
Biotech KONTACT®

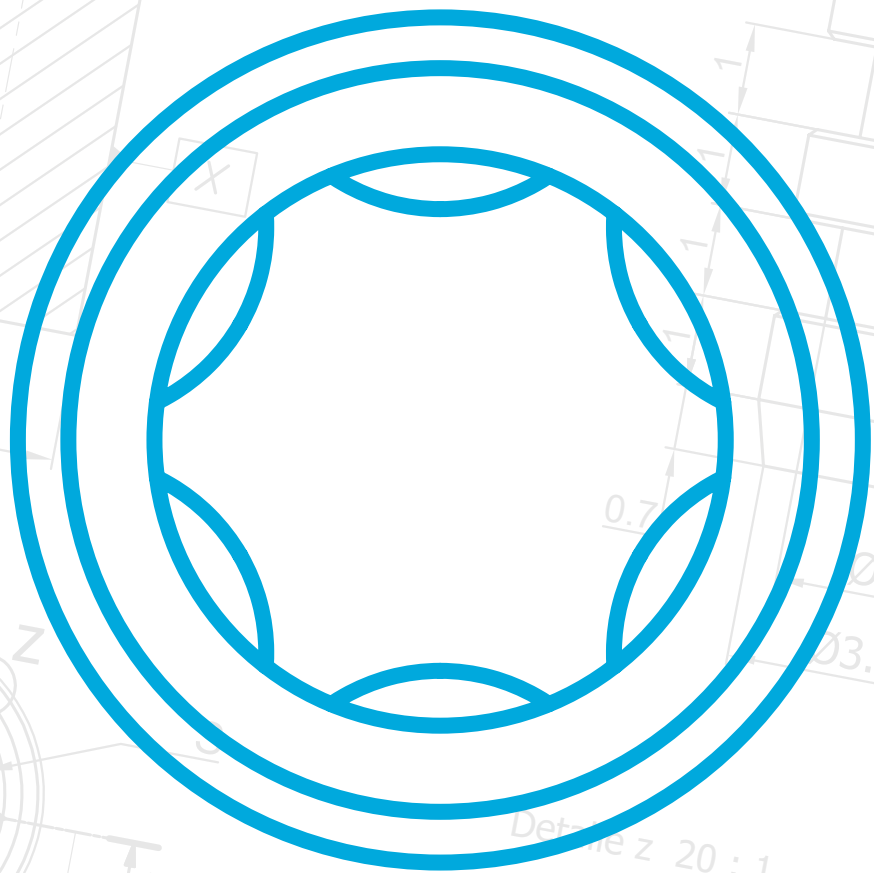

Screw hex

Biotech Kontakt®
equivalent prosthetic platform

MULTIUNIT

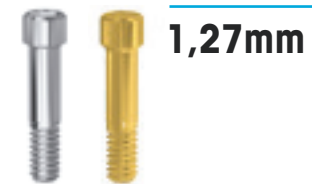

TIN coated

	NP	RP
19.078	19.063	19.064
19.678	19.663	19.664

Analogue



14.078

Our analogues are suitable for both 3D and traditional models.

Ti base



- 15.078
- 16.078

Ti base Castables

Pack of 5



- 32.001-P5
- 33.001-P5

Scan abutments



for intra-oral scanning

52.078

on Ti base

Pack of 10

- 53.100-P10
- 53.200-P10

All abutments include final screw. Transfers include two screws (for open and closed tray).

● non-engaging ● engaging

NEW
COMPATIBILITY

INTERNAL BT

compatible with
BTI®



Screw hex

BTI®
equivalent prosthetic platform

4.1 MULTI-UNIT



1,27mm

19.079	19.065
19.679	19.665

Analogue



14.079

Our analogues are suitable for both 3D and traditional models.

Ti base



●	15.079
●	16.079

Ti base Castables



Pack of 5

●	32.001-P5
●	33.001-P5

Scan abutments



for intra-oral scanning

52.079

on Ti base

Pack of 10

●	53.100-P10
●	53.200-P10

All abutments include final screw. Transfers include two screws (for open and closed tray).

● non-engaging ● engaging

MULTI-UNIT CONNECTION

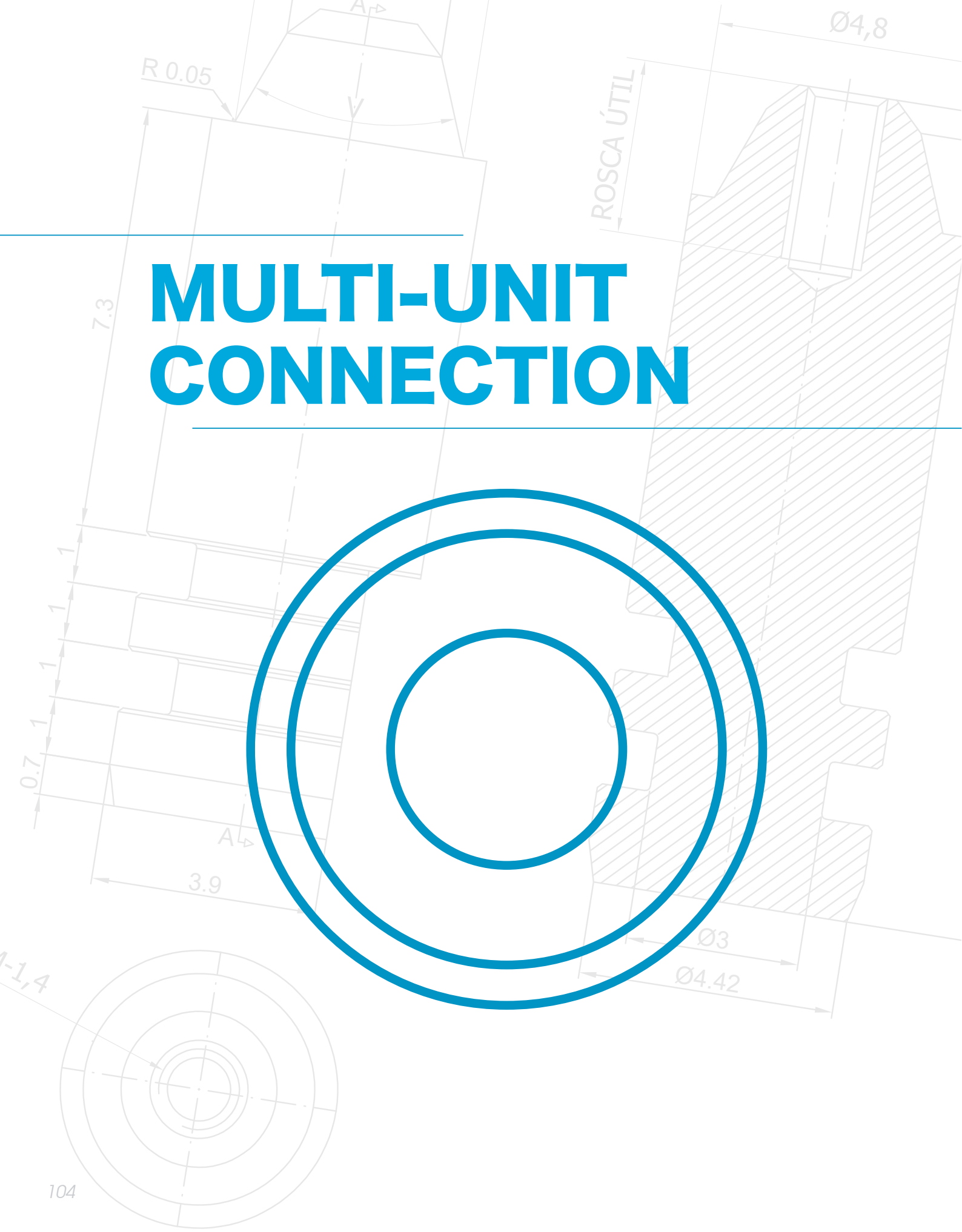

DESS
Prosthetic Plattform

	RP MULTI-UNIT 4.8	WP PLATFORM 6.5
--	-------------------------	-----------------------

Screw hex ug



Pack of 10
with DLC-coating

NEW
TIN coated



Screw hex. 1,27mm

	19.006	19.031
Pack of 10	19.006-P10	19.031-P10
	19.206	19.231
	19.606	19.631
	19.110	

Analogue



Pack of 10

	14.007	14.047
Pack of 10	14.007-P10	14.047-P10

Our analogues are suitable for both 3D and traditional models.

Ti base



GH
0,3mm
Ti base Castables
0,3mm

Pack of 5

	15.007	15.054
	15.007/8	
Pack of 5	32.007-P5	32.054-P5

CoCr base



for welding techniques



DESS CoCr Ingots

1kg

CRC01000

	30.007	30.054
	30.107	

Castable



Pack of 10

	28.007	28.054
Pack of 10	11.007-P10	11.054-P10

AURUMBase®

	RP MULTI-UNIT 4.8	WP PLATFORM 6.5
--	-------------------------	-----------------------



Torx® Screw

	19.306	19.331
--	--------	--------



DESS
AURUMBase®

	36.007	36.054
--	--------	--------

Torx® ball Screwdriver
20 mm DT20TB06 24 mm DT24TB06 35 mm DT35TB06

spherical head for angulated screw channels up to 25°

Up to 25°
Angulated
Screw
Channel



DESS
prosthetic platform

RP	WP
MULTI-UNIT 4.8	PLATFORM 6.5

Transfer



for closed tray only



5,0mm

17.507

5,0mm

Pack of 4

17.507-P4

8,0mm

17.807

8,0mm

Pack of 4

17.807-P4

Temporary abutments



24.007

24.030

Healing abutments



20.100

20.054

DESSLoc®



88.007

Scan abutments



for desktop scanning
* use indicated screw

50.007

50.047

* 19.006

* 19.031



for intra-oral scanning

52.007

52.047

DESS
prosthetic platform

NP	RP	WP
MULTI-UNIT PLATFORM 4.8		

Active Hex

NobelActive® & NobelReplace® CC



Straight

1,5mm



40.007/1

40.008/1

2,5mm



40.007/2

40.008/2

3,5mm



40.007/3

40.008/3

4,5mm



40.008/4



Angled 17°

2,5mm



41.707/2

41.708/2

3,5mm



41.707/3

41.708/3



Angled 30°

3,5mm



43.007/3

43.008/3

4,5mm



43.007/4

43.008/4

Tri-lobe

NobelReplace Select™



Straight

1,0mm



40.004/1

40.005/1

40.006/1

2,0mm



40.004/2

40.005/2

40.006/2

3,0mm



40.004/3

40.005/3

40.006/3

4,0mm



40.005/4

5,0mm



40.005/5



Angled 17°

2,0mm



41.704/2

41.705/2

3,0mm



41.704/3

41.705/3

4,0mm



41.705/4



Angled 30°

4,0mm



43.005/4

4,0mm



43.005/4R

5,0mm



43.005/5

5,0mm



43.005/5R

External Hex Universal

Nobel Brånemark®



Straight

1,0mm



40.001/1

40.002/1

40.003/1

2,0mm



40.001/2

40.002/2

40.003/2

3,0mm



40.001/3

40.002/3

40.003/3

4,0mm



40.002/4

5,0mm



40.002/5



Angled 17°

2,0mm



41.701/2

41.702/2

3,0mm



41.701/3

41.702/3

4,0mm



41.702/4



Angled 30°

4,0mm



43.002/4

4,0mm



43.002/4R

5,0mm



43.002/5

5,0mm





43.002/5R



Angled Multiunits include DLC SCREW.

DESS
prosthetic platform

External hex usa
3i Osseotite®



		NP		RP		WP	
		MULTI-UNIT PLATFORM 4.8					
	Straight	1,0mm	●	40.009/1	40.017/1		
		2,0mm	●	40.009/2	40.017/2		
		3,0mm	●	40.009/3	40.017/3		
		4,0mm	●		40.017/4		
		5,0mm	●		40.017/5		
	Angled 17°	2,0mm	●		41.712/2		
		3,0mm	●		41.702/3*		
		4,0mm	●		41.702/4*		
	30°	3,0mm	●		43.012/3		
		4,0mm	●		43.012/4		
		5,0mm	●		43.012/5		

Conical BL
Straumann® bone level



	Straight	1,5mm	●	40.043/1	40.044/1		
		2,5mm	●	40.043/2	40.044/2		
		3,5mm	●	40.043/3	40.044/3		
		4,5mm	●		40.044/4		
	Angled 17°	2,5mm	●	41.743/2	41.744/2		
		3,5mm	●	41.743/3	41.744/3		
	30°	3,5mm	●	43.043/3	43.044/3		
		4,5mm	●	43.043/4	43.044/4		

DESS
prosthetic platform

Internal Hex USA
Zimmer Screw-vent®

		NP		RP		WP	
		MULTI-UNIT PLATFORM 4.8					
	Straight	1,0mm	●	40.019/1	40.020/1		
		2,0mm	●	40.019/2	40.020/2		
		3,0mm	●	40.019/3	40.020/3		
		4,0mm	●		40.019/4		
		5,0mm	●		40.019/5		
	Angled 17°	2,5mm	●		41.719/2		
		3,5mm	●		41.719/3		
	30°	3,5mm	●		43.019/3		
		4,5mm	●		43.019/4		

Internal Hex MI
MIS® Seven

	Straight	1,0mm	●	40.019/1	40.020/1		
		2,0mm	●	40.019/2	40.020/2		
		3,0mm	●	40.019/3	40.020/3		
		4,0mm	●		40.019/4		
		5,0mm	●		40.019/5		
	Angled 17°	2,5mm	●		41.719/2		
		3,5mm	●		41.719/3		
	30°	3,5mm	●		43.019/3		
		4,5mm	●		43.019/4		

DESSLoc

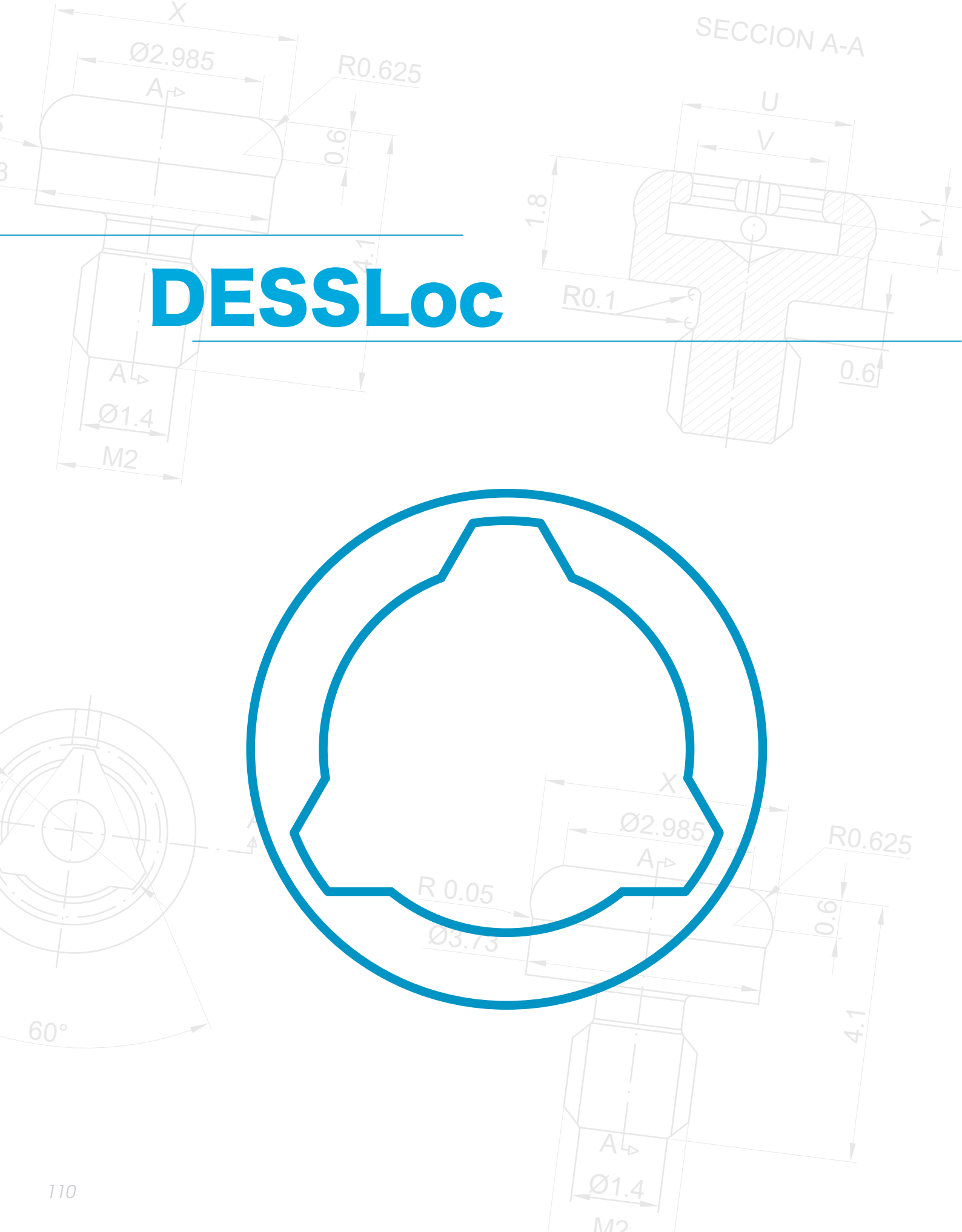

Analogue



Pack of 10

14.054

14.054-P10

Transfer



17.054

Our analogues are suitable for both 3D and traditional models.

Retention Kits



divergence
between
implants

up to 20° x1
up to 20° x2

* divergence up to 40°

DLRK-P1

DLRK-P2



up to 40° x1
up to 40° x2

DLER-P1

DLER-P2

Males



divergence
between
implants

up to 20° x4
up to 20° x4
up to 20° x4
up to 40° x4
up to 40° x4
up to 40° x4

1.5 lbs / 680g
3.0 lbs / 1360g
5.0 lbs / 2270g
1.0 lbs / 450g
2.0 lbs / 910g
4.0 lbs / 1810g

DLN2-P4
DLN3-P4
DLN4-P4
DLN1-P4
DLN6-P4
DLN7-P4

Tools



DESSLoc Removal & Insertion Tool

PHLOC

SPECIAL TOOLS



DESSLoc

DTLOC



Adaptor from straumann®
torque wrench to square
connection

DTSTSQ

Active Hex

NobelActive® NobelReplace® CC



1,0mm
2,0mm
3,0mm
4,0mm

NP

RP

	PURPLE 3.5	YELLOW 4.3-5.0
1,0mm	88.039/1	88.040/1
2,0mm	88.039/2	88.040/2
3,0mm	88.039/3	88.040/3
4,0mm	88.039/4	88.040/4

Tri-Lobe

Nobel Replace Select™



1,0mm
2,0mm
3,0mm
4,0mm

	PURPLE 3.5	YELLOW 4.3
1,0mm	88.004/1	88.005/1
2,0mm	88.004/2	88.005/2
3,0mm	88.004/3	88.005/3
4,0mm	88.004/4	88.005/4

External Hex Universal

NobelBrånemark®



1,0mm
2,0mm
3,0mm
4,0mm
5,0mm

3.5 4.1

1,0mm	88.001/1	88.002/1
2,0mm	88.001/2	88.002/2
3,0mm	88.001/3	88.002/3
4,0mm		88.002/4
5,0mm		88.002/5

External Hex USA

3i Osseotite®



1,0mm
2,0mm
3,0mm
4,0mm
5,0mm

	PURPLE 3.4	BLUE 4.1
1,0mm	88.011/1	88.002/1
2,0mm	88.011/2	88.002/2
3,0mm	88.011/3	88.002/3
4,0mm	88.011/4	88.002/4
5,0mm		88.002/5

Internal Hex "CLICK"

3i Certain®



1mm
2mm
3mm
4mm

	PURPLE 3.4	BLUE 4.1
1mm	88.014/1	88.015/1
2mm	88.014/2	88.015/2
3mm	88.014/3	88.015/3
4mm	88.014/4	88.015/4
		88.002/5

Octagon

Straumann® Soft Tissue Level & synOCTA®



1,0mm
2,0mm
3,0mm
4,0mm

4.8
RN

1,0mm	88.009/1
2,0mm	88.009/2
3,0mm	88.009/3
4,0mm	88.009/4

Conical BL

Straumann® Bone Level



1,0mm
2,0mm
3,0mm
4,0mm

NP RP WP

	NC 3.3	RC 4.1
1,0mm		88.042/1
2,0mm	88.041/2	88.042/2
3,0mm	88.041/3	88.042/3
4,0mm	88.041/4	88.042/4

Internal Hex USA

Zimmer Screw-vent®



1,0mm
2,5mm
3,5mm
4,5mm
5,5mm

	GREEN / 3.5	PURPLE / 4.5
1,0mm	88.017/1	88.018/1
2,5mm	88.017/2	88.018/2
3,5mm	88.017/3	88.018/3
4,5mm	88.017/4	88.018/4
5,5mm	88.017/5	

Conic EVO

Astra Tech Implant System™ EV



1,0mm
2,0mm
3,0mm
4,0mm

	PURPLE 3.6	YELLOW 4.2	BLUE 4.8
1,0mm	88.059/1	88.060/1	88.061/1
2,0mm	88.059/2	88.060/2	88.061/2
3,0mm	88.059/3	88.060/3	88.061/3
4,0mm	88.059/4	88.060/4	88.061/4

Internal Hex Conic

Astra Tech Osseospeed™



1,0mm
2,0mm
3,0mm
4,0mm

	AQUA 3.5-4.0	LILAC 4.5-5.0
1,0mm	88.024/1	88.025/1
2,0mm	88.024/2	88.025/2
3,0mm	88.024/3	88.025/3
4,0mm	88.024/4	88.025/4

Internal Hex FD

Dentsply friadent® XIVE®



1,0mm
2,0mm
3,0mm
4,0mm

	SILVER 3.4	YELLOW 3.8
1,0mm	88.036/1	88.037/1
2,0mm	88.036/2	88.037/2
3,0mm	88.036/3	88.037/3
4,0mm	88.036/4	88.037/4

Internal ANK

Ankylos® C/X



2,0mm
3,0mm
4,0mm

2,0mm	88.046/2
3,0mm	88.046/3
4,0mm	88.046/4



Internal CAM

Camlog®



1,0mm
2,0mm
3,0mm
4,0mm

NP

YELLOW
3.8

88.065/1
88.065/2
88.065/3
88.065/4

RP

PINK
4.3

88.066/1
88.066/2
88.066/3
88.066/4

Internal Hex BH

Biohorizons® Internal



1,0mm
2,5mm
3,5mm
4,5mm
5,5mm

YELLOW
3.5

88.017/1
88.017/2
88.017/3
88.017/4
88.017/5

GREEN
4.5

88.018/1
88.018/2
88.018/3
88.018/4

Internal Hex MI

MIS® Seven



1,0mm
2,5mm
3,5mm
4,5mm
5,5mm

PURPLE / STD

88.017/1
88.017/2
88.017/3
88.017/4
88.017/5

GREEN / WIDE

88.018/1
88.018/2
88.018/3
88.018/4

Multi-Unit Connection

Multi-Unit® Abutments



MULTI-UNIT
4.8

88.007

Bar Attachment



88.100

AURUMBase®



Angular freedom

AURUMBase® is our answer to clinical situations where the long-axis of the implant results in an unfavorable location of the prosthetic screw access hole.

- Full recommended torque at maximum angle
- Up to 25° angle
- 360° freedom positioning
- Flat seat screw design

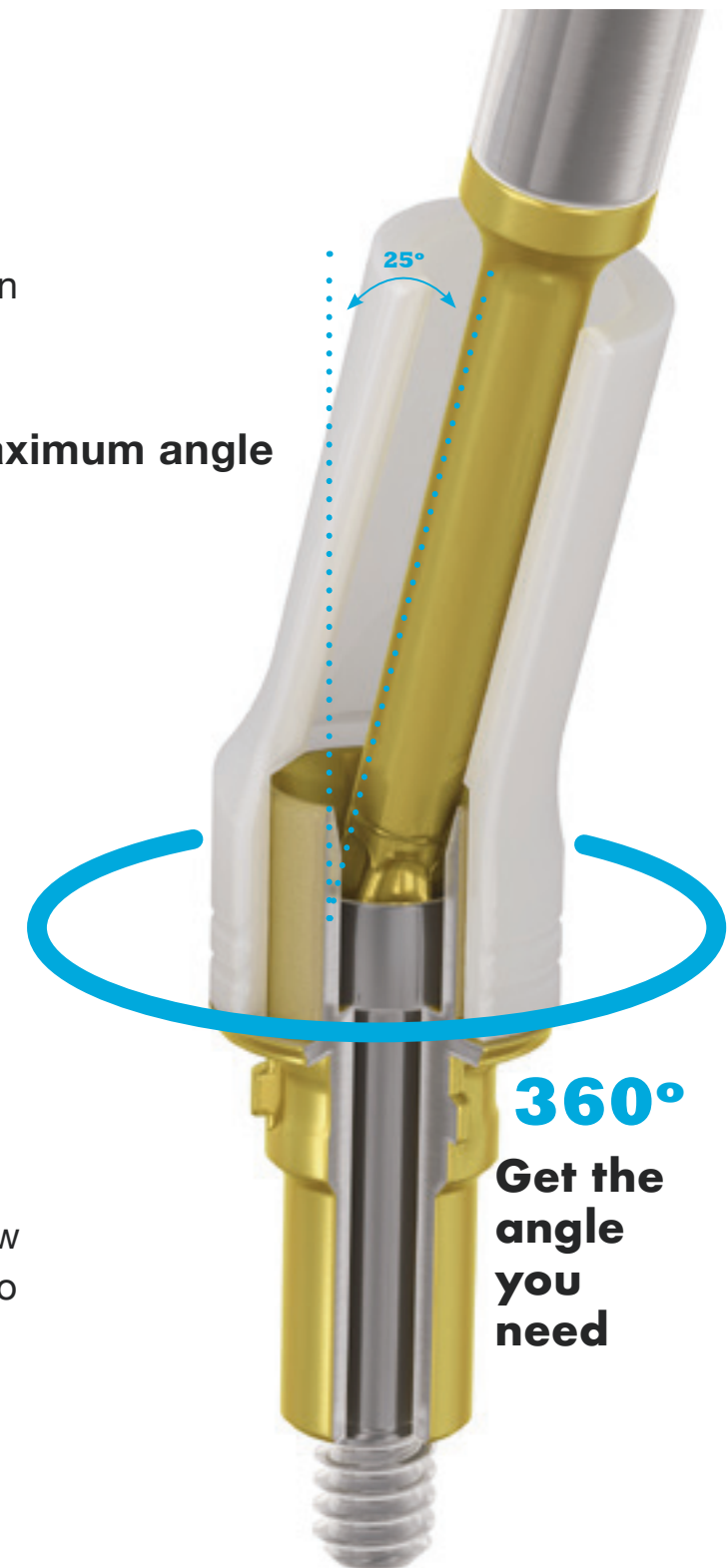
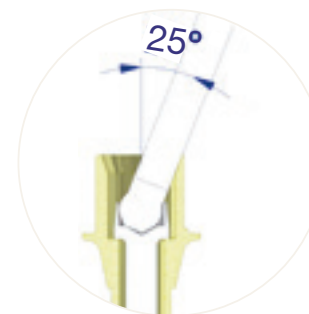

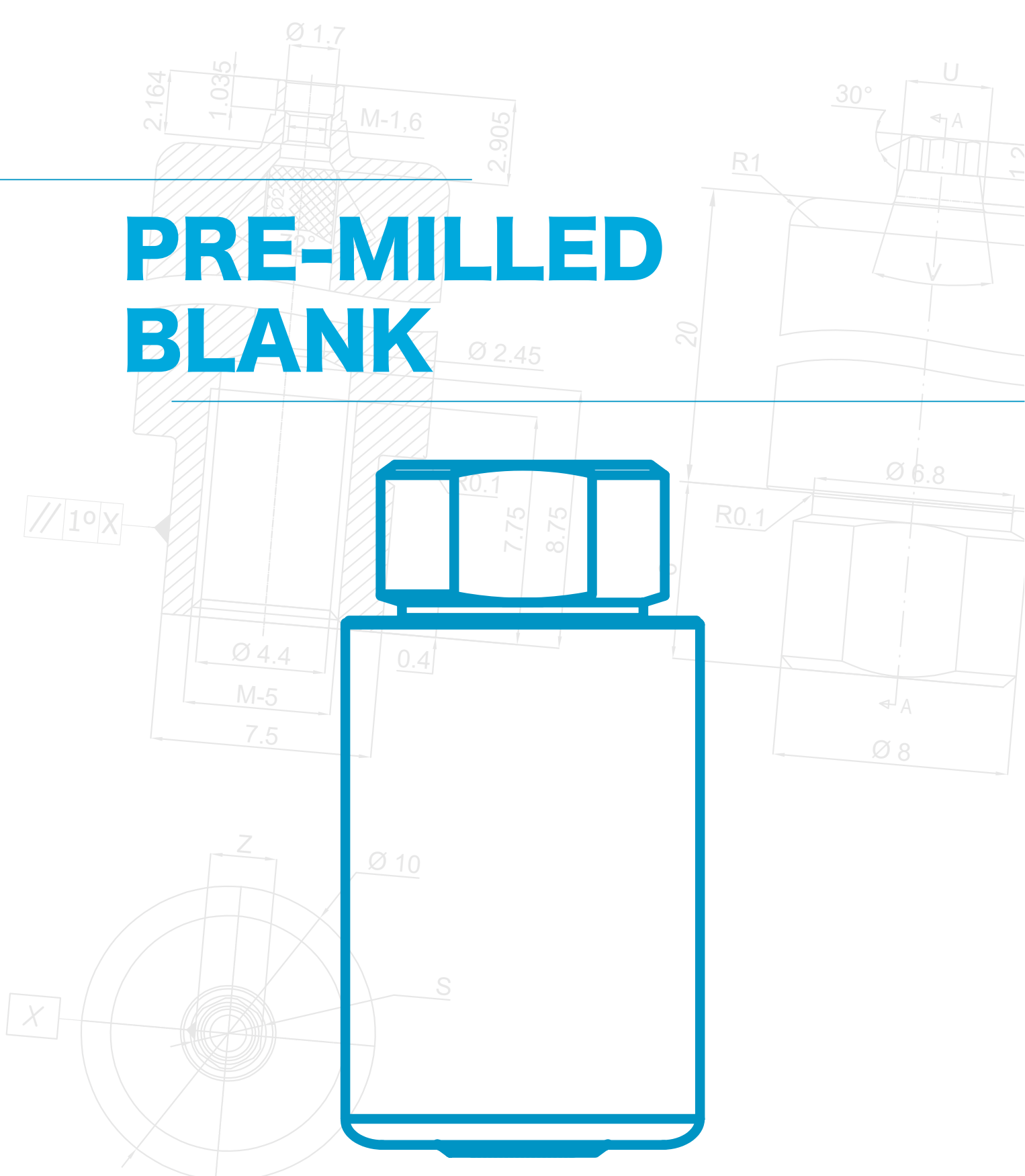

The specially designed Torx® based screw and driver concept will retain the ability to use full recommended torque even at full angulation.

PRE-MILLED BLANK



		3.0	NP 3.5	RP 4.3-5.0	WP	
Active Hex NobelActive® NobelReplace® CC		3.0	PURPLE 3.5	YELLOW 4.3-5.0	WP	
	Ti	Ø10mm	61.068	61.041	61.042	61.069
	CoCr	NEW Ø14mm		62.041	62.042	
Ø14mm		71.068	71.041	71.042	71.069	

		PURPLE 3.5	YELLOW 4.3	BLUE 5.0	6.0	
Tri-Lobe Nobel Replace Select™						
	Ti	Ø10mm	61.004	61.005	61.006	61.097
	CoCr	Ø14mm		62.005	62.006	62.097
Ø14mm		71.004	71.005	71.006	71.097	

		3.5	4.1	5.1	
External Hex Universal NobelBranemark®					
	Ti	Ø10mm	61.001	61.002	61.003
	CoCr	Ø14mm	71.001	71.002	71.003

		PURPLE 3.4	BLUE 4.1	YELLOW 5.0	
External Hex USA 3i Osseotite®					
	Ti	Ø10mm	61.011	61.012	61.013
	CoCr	Ø14mm	71.011	71.012	71.013

		PURPLE 3.4	BLUE 4.1	YELLOW 5.0	
Internal Hex "CLICK" 3i Certain®					
	Ti	Ø10mm	61.014	61.015	61.016
	CoCr	Ø14mm		62.015	62.016
Ø14mm		71.014	71.015	71.016	

Octagon

Straumann® Soft Tissue Level & synOCTA®



			NP 3.5	RP 4.8	WP 6.5
Ti	ø10mm		61.070	61.009	61.045
	ø14mm	NEW		62.009	62.045
CoCr	ø14mm		71.070	71.009	71.045

Conical BL

Straumann® Bone Level



			NC 3.3	RC 4.1
Ti	ø10mm		61.043	61.044
	ø14mm	NEW	62.043	62.044
CoCr	ø14mm		71.043	71.044

Internal Hex USA

Zimmer Abutmentschrauben-vent®



			GREEN 3.5	PURPLE 4.5	YELLOW 5.7
Ti	ø10mm		61.017	61.018	61.019
	ø14mm	NEW	62.017	62.018	62.019
CoCr	ø14mm		71.017	71.018	71.019

Conic EVO

Astra Tech Implant System™ EV



			PURPLE 3.6	YELLOW 4.2	BLUE 4.8
Ti	ø10mm		61.059	61.060	61.061
	ø14mm		62.059	62.060	62.061
CoCr	ø14mm		71.059	71.060	71.061

Internal Hex Conic

Astra Tech Osseospeed™



			NP 3.0	AQUA 3.5-4.0	LILAC 4.5-5.0
Ti	ø10mm		61.023	61.024	61.025
				62.024	62.025
CoCr	ø14mm			71.024	71.025

Internal Hex FD

Dentsply friadent® XIVE®



			3.3 SILVER 3.4	NP RP 3.8 YELLOW 3.8	WP 4.5 BLUE 4.5	5.5 RED 5.5
Ti	ø10mm		61.038	61.039	61.040	61.071
	ø14mm			62.039	62.040	62.071
CoCr	ø14mm		71.038	71.039	71.040	71.071

Internal ANK

Ankylos® C/X



Ti	ø10mm		61.250*
CoCr	ø14mm		71.250*

*available only in 3mm height

Conic oss

Osstem® TS



			YELLOW MINI	GREEN REGULAR
Ti	ø10mm		61.072	61.073
	ø14mm		62.072	62.073
CoCr	ø14mm		71.072	71.073

Internal CAM

Camlog®



			SILVER 3.3	YELLOW 3.8	PINK 4.3	BLUE 5.0
Ti	ø10mm		61.064	61.065	61.066	61.067
	ø14mm			62.065	62.066	62.067
CoCr	ø14mm		71.064	71.065	71.066	71.067

Internal CON

Conelog®



			3.3	3.8	5.0
Ti	ø10mm		61.074	61.075	61.076
CoCr	ø14mm		71.074	71.075	71.076



NP RP WP

GREEN 4.2 BLUE 5.2

External Hex BH

Biohorizons®



Ti	∅10mm	61.021	61.022
CoCr	∅14mm	71.021	71.022

Internal Hex MI

MIS® Seven



Ti	∅10mm	61.095	61.096
CoCr	∅14mm	71.095	71.096

Conic ANYR

Megagen AnyRidge®



Ti	∅10mm		61.057
CoCr	∅14mm		71.057

CONIC IC

Medentis ICX®



Ti	∅10mm	61.080	
	∅14mm	62.080	
CoCr	∅14mm	71.080	

Conic DENT

Dentium Superline™ & Implantium®



			3.8
Ti	∅10mm	61.090	
CoCr	∅14mm	71.090	

Blocks



Ti	□15mm L 20 mm	63.020	
Ti	□15mm L 40 mm	63.040	

HOLDERS



for standard 98mm disc machines

Any milling machine with a 98 mm disc holder HLDSTD



for Imes-Icore® machines

Coritec 245i touch HLDIMES
Coritec 250i touch
Coritec 350i / Coritec 350i Loader
Coritec 450i
Coritec 550i
Coritec 650i / Coritec 650i Loader



for VHF

VHF S1 HLDVHF
VHF S2
VHF K5



NEW

for VHF R5

HLDVHFR5



for VHF N4

HLDVHFN4



for VHF Z4

HLDVHFZ4



for machines with support/changer 3R Yenadent® D14P & others

HLD3R

Holders for machines with support/changer 3R Yenadent® D14P & other 20 positions machines

Adaptors for ZirkonZahn® holders



Adaptors for ZirkonZahn® machines

M1 abutment HLDZZ
M1 wet heavy metal
M4 wet heavy metal
M5 heavy metal
M6 wet heavy metal

TOOLS

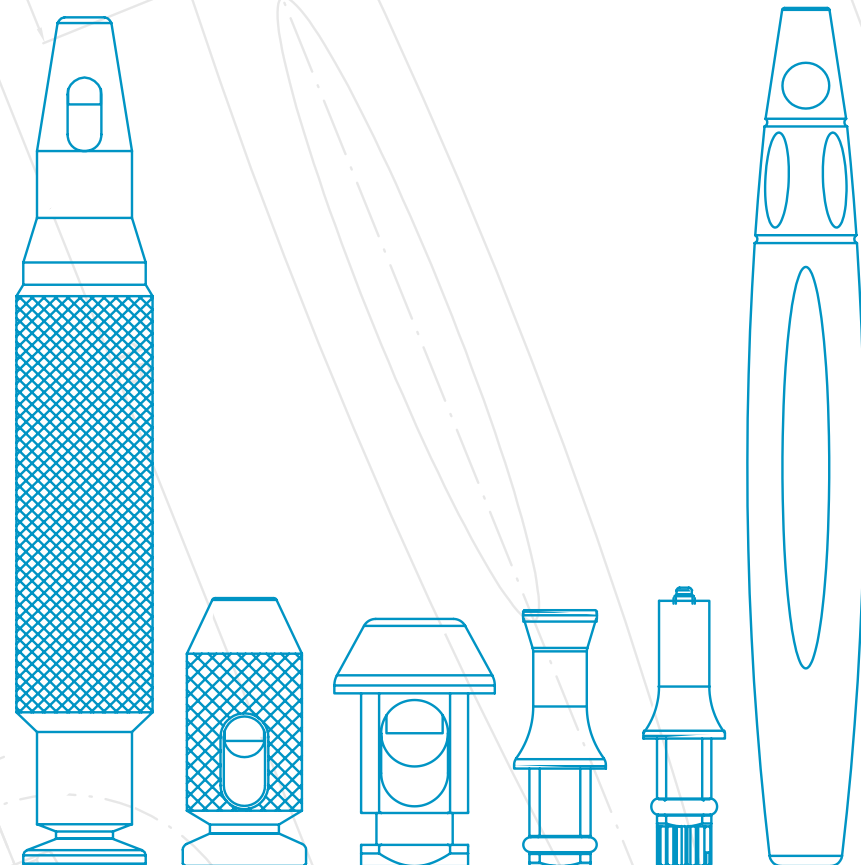

Screwdriver HEX 18mm 20mm 24mm 35mm COMPATIBLE WITH



0,90mm	DT20H090	DT24H090			
1,00mm	DT20H100	DTC24H100	DT35H100	Dentsply Ankylos® C/X	
1,20mm	DT18H120	DT20H120	DT24H120	DT35H120	3i® Osseotite® 3i® Certain®
1,22mm	DT20H122	DT24H122	DT35H122		Dentsply Friadent Xive® Hiossen TS Global D, BTI
1,25mm	DT20H125	DT24H125			
1,27mm	DTC20H127	DT24H127	DT35H127		Astra Tech™ OsseoSpeed™ Zimmer Screw-Vent® & MIS® MIS® C1 MIS® V3 Seven BioHorizons® Astra Tech Implant System EV™ Camlog® Bego
1,30mm	DT20H130	DT24H130			
1,50mm	DT20H150	DT24H150			
1,70mm	DT20H170	DT24H170			
1,75mm	DT20H175	DT24H175			

Screwdriver SQ



1,30mm	DT20S130	DT24S130		
--------	----------	----------	--	--

Screwdriver Torx® 06



DT20T06	DT24T06	DT35T06		Straumann® Soft Tissue Level Implants & synOcta® Bone Level®
---------	---------	---------	--	-----------------------------------------------------------------



DT20TB06	DT24TB06	DT35TB06		spherical head for angulated screw channels up to 25°
----------	----------	----------	--	----------------------------------------------------------

Screwdriver UniGrip®



DT20U	DT24U	DT35U		Nobel Brånemark® Nobel Replace® Select™ Nobel Active™ & Nobel Replace® CC Multi-unit®
-------	-------	-------	--	------------------------------------------------------------------------------------------------

SCREWDRIVER HANDLES

Laboratory handle		
		MDTLAA
Premium laboratory handle		
		PHLAB
Dentist handle		
	7mm	MDTMAN700
	9mm	MDTMAN900
DESS LOC Removal & Insertion Tool		
		PHLOC
DESS CoCr		
		CRCO1000

SPECIAL TOOLS

	Multi-unit® RP	DTMURP
	Multi-unit® WP	DTMUWP
	UniAbutment®	DTUNI
	Octagon	DTSYN
	Torque wrench adaptor	TWADAP
	DESS LOC	DTLOC
	Adaptor from straumann® torque wrench to square connection	DTSTSQ
	Straumann® contra-angles adaptor	DTSTCA
	Nobel Biocare™ Adapter from 8mm to 4x4	DTNBSQ
	Nobel Biocare™ contra-angles adaptor	DTNBCA
	Handpiece adaptor for Square Connection	DTANGSQ
	Manual driver for Intraoral Scan abutment	DTPEI

CLINICAL SCREWS RECOMMENDED TORQUE



ún ISO 10664:2005

ACTIVE HEX

FITS
NOBELACTIVE® &
NOBELREPLACE® CC



TRI-LOBE

FITS
NOBEL REPLACE
SELECT™



PLATFORM SIZE	DESS REF. N°	DESS RECOMMENDED TORQUE (Ncm)	ORIGINAL EQUIVALENT REF. N°
3.0	19.068	15	Nobel Biocare® 36805
3.0	19.268	15	Nobel Biocare® 37890
3.0	19.668	15	
NP	19.027	35	Nobel Biocare® 31168
NP	19.227	35	Nobel Biocare® 29282
NP	19.101	35	
NP	19.327	35	
NP	19.627	35	
NP AURUMBase®	19.441	35	
RP	19.030	35	Nobel Biocare® 28815
RP	19.230	35	Nobel Biocare® 36918
RP	19.328	35	
RP	19.630	35	
RP AURUMBase®	19.442	35	
On1®	19.021	35	Nobel Biocare® 38751
On1®	19.221	35	Nobel Biocare® 38750
On1®	19.621	35	
NP on implant for Multi-unit®	19.507	35	
RP on implant for Multi-unit®	19.508	35	
NP	19.004	35	Nobel Biocare® 31170
NP	19.204	35	Nobel Biocare® 36818
NP	19.304	35	
NP	19.604	35	
NP AURUMBase®	19.404	35	
RP/WP/6.0	19.005	35	Nobel Biocare® 29293
RP/WP/6.0	19.205	35	Nobel Biocare® 29475
RP/WP/6.0	19.305	35	
RP/WP/6.0	19.605	35	
RP/WP AURUMBase®	19.405	35	
NP on implant for Multi-unit®	19.504	35	
RP on implant for Multi-unit®	19.505	35	

EXT HEX UNIVERSAL

FITS NOBELBRÄNEMARK®



PLATFORM SIZE	DESS REF. N°	DESS RECOMMENDED TORQUE (Ncm)	ORIGINAL EQUIVALENT REF. N°
NP	19.027	35	Nobel Biocare® 31168
NP	19.227	35	Nobel Biocare® 29282
NP	19.327	35	
NP	19.101	35	
NP	19.627	35	
NP AURUMBase®	19.401	35	
RP	19.028	35	Nobel Biocare® 29290
RP	19.228	35	Nobel Biocare® 29283
RP	19.328	35	
RP	19.628	35	
RP AURUMBase®	19.402	35	
WP	19.029	35	Nobel Biocare® 31169
WP	19.229	35	Nobel Biocare® 29284
WP	19.329	35	
WP	19.629	35	
NP on implant for Multi-unit®	19.501	35	
RP on implant for Multi-unit®	19.502	35	

EXT HEX USA

FITS 3i OSSEOTITE®



PLATFORM SIZE	DESS REF. N°	DESS RECOMMENDED TORQUE (Ncm)	ORIGINAL EQUIVALENT REF. N°
NP/RP/WP	19.034	20	Biomet 3i® UNIHT
NP/RP/WP	19.634	20	
NP/RP/WP AURUMBase®	19.402	20	
RP on implant for Multi-unit®	19.512	20	
Low Profile® Abutment ø4.8	19.106	10	Biomet 3i® LPCTSH

INT HEX CLIK

FITS 3i CERTAIN®



PLATFORM SIZE	DESS REF. N°	DESS RECOMMENDED TORQUE (Ncm)	ORIGINAL EQUIVALENT REF. N°
NP/RP/WP	19.011	20	Biomet 3i® IUNIHT
NP/RP/WP	19.311	20	
NP/RP/WP	19.611	20	
NP/RP/WP AURUMBase®	19.438	20	
Low Profile® Abutment ø4.8	19.106	10	Biomet 3i® LPCTSH

OCTAGON

FITS STRAUMANN® SOFT TISSUE LEVEL & synOCTA®



PLATFORM SIZE	DESS REF. N°	DESS RECOMMENDED TORQUE (Ncm)	ORIGINAL EQUIVALENT REF. N°
NNC	19.070	35	Straumann® AG 048.314
NNC	19.670	35	
RN/WN on implant	19.026	35	Straumann® AG 048.356
RN/WN on implant	19.102	35	Straumann® AG 049.181
RN/WN on implant	19.328	35	
RN/WN on implant	19.626	35	
RN/WN AURUMBase®	19.446	35	
RN/WN on synOcta® abutment	19.009	15	Straumann® AG 048.350
RN/WN on synOcta® abutment	19.103	15	
RN/WN on synOcta® abutment	19.609	15	

CONICAL BL

FITS STRAUMANN® BONE LEVEL



PLATFORM SIZE	DESS REF. N°	DESS RECOMMENDED TORQUE (Ncm)	ORIGINAL EQUIVALENT REF. N°
NC on implant	19.032	35	Straumann® AG 025.2908
NC on implant	19.632	35	
RC on implant	19.033	35	Straumann® AG 025.4908
RC on implant	19.633	35	
NC/RC on implant	19.037	35	Straumann® AG 025.4900
NC/RC on implant	19.104	35	Straumann® AG 025.4906
NC/RC on implant	19.311	20	
NC/RC AURUMBase®	19.443	35	
NC/RC on implant for Multi-unit®	19.544	35	
NC/RC on Multi-base® abutment	19.041	15	Straumann® AG 025.0900-04
NC/RC on Multi-base® abutment	19.105	15	
NC/RC on SRA® abutment	19.098	15	Straumann® AG 023.4763

INT HEX USA

FITS ZIMMER SCREW-VENT®



PLATFORM SIZE	DESS REF. N°	DESS RECOMMENDED TORQUE (Ncm)	ORIGINAL EQUIVALENT REF. N°
NP/RP/WP	19.012	30	Zimmer® URS2
NP/RP/WP	19.012L	30	
NP/RP/WP	19.042	30	Zimmer® MHLAS
NP/RP/WP	19.642	30	
NP/RP/WP	19.312	30	
NP/RP/WP AURUMBase®	19.417	30	
NP (MIS®)	19.327	35	
NP on implant for Multi-unit®	19.519	30	
RP on Multi-unit® abutment ø4.8	19.110	15	
RP on Multi-unit® abutment ø4.8	19.300	15	

CONIC EVO

FITS ASTRA TECH IMPLANT SYSTEM™ EV



PLATFORM SIZE	DESS REF. N°	DESS RECOMMENDED TORQUE (Ncm)	ORIGINAL EQUIVALENT REF. N°
3.6 on implant	19.059	25	
3.6 on implant	19.659	25	
3.6 AURUMBase®	19.441	25	
4.2 on implant	19.060	25	
4.2 on implant	19.660	25	Astra Tech® 25.205
4.2 AURUMBase®	19.460	25	
4.8 on implant	19.061	25	
4.8 on implant	19.661	25	
4.8 AURUMBase®	19.461	25	
UniAbutment® EV	19.058	15	
UniAbutment® EV	19.658	15	

INT HEX CONIC

FITS ASTRA TECH OSSEOSPEED™



PLATFORM SIZE	DESS REF. N°	DESS RECOMMENDED TORQUE (Ncm)	ORIGINAL EQUIVALENT REF. N°
NP on implant	19.015	15	Dentsply® 24189
NP on implant	19.615	15	
RP on implant	19.016	20	Dentsply® 24449
RP on implant	19.616	20	
RP AURUMBase®	19.441	20	
WP on implant	19.017	25	Dentsply® 24209
WP on implant	19.617	25	
WP AURUMBase®	19.425	25	
UniAbutment® 20°/45°	19.018	15	Dentsply® 22435
UniAbutment® 20°/45°	19.618	15	

INT HEX FD

FITS
DENTSPLY
FRIADENT XIVE®



PLATFORM SIZE	DESS REF. N°	DESS RECOMMENDED TORQUE (Ncm)	ORIGINAL EQUIVALENT REF. N°
NP/RP/WP	19.024	24	Dentsply® 454305
NP/RP/WP	19.624	24	
NP/RP/WP AURUMBase®	19.438	24	

INT ANK

FITS
DENTSPLY
ANKYLOS® C/X



All platforms	19.048	15	
All platforms	19.050	15	
All platforms	19.648	15	

CONIC OSS

FITS
OSSTEM® TS



Mini on implant	19.072	20	
Mini on implant	19.672	20	
Mini AURUMBase®	19.444	20	
Standard on implant	19.073	30	Osstem® GSABSST
Standard on implant	19.673	30	
Standard AURUMBase®	19.461	30	

INT CAM

FITS
CAMLOG®



3,3 / 3,8 / 4,3 on implant	19.044	20	
3,3 / 3,8 / 4,3 on implant	19.644	20	Camlog® J4005. 1601
3,8 / 4,3 AURUMBase®	19.444	20	
5.0 on implant	19.045	20	Camlog® J4005. 2001
5.0 on implant	19.645	20	

INT CON

FITS
CONELOG®



3,3 / 3,8 / 4,3 on implant	19.074	20	Camlog® C4005. 1601
3,3 / 3,8 / 4,3 on implant	19.674	20	
5.0 on implant	19.076	20	Camlog® C4005. 2001
5.0 on implant	19.676	20	

INT HEX BH

FITS
BIOHORIZONS®
INTERNAL



On implant	19.043	30	BioHorizons® PXAS
On implant	19.043	30	
Multi-unit® RP ø4.8	19.006	15	Nobel Biocare® 29287
Low Profile® abutment ø4.8	19.106	10	Biomet 3i® LPCTSH
Multi-unit® RP ø4.8	19.110	15	
Multi-unit® RP ø4.8	19.206	15	Nobel Biocare® 29285
Multi-unit® RP ø4.8 AURUMBase®	19.306	15	
Multi-unit® RP ø4.8	19.606	15	
MIS® Multi-unit® RP ø4.8	19.300	15	
Multi-unit® WP ø6.0	19.031	15	Nobel Biocare® 31163
Multi-unit® WP ø6.0	19.231	15	Nobel Biocare® 29286
Multi-unit® WP ø6.0 AURUMBase®	19.331	15	
Multi-unit® WP ø6.0	19.631	15	

EXT HEX BH

FITS
BIOHORIZONS®
EXTERNAL



PLATFORM SIZE	DESS REF. N°	DESS RECOMMENDED TORQUE (Ncm)	ORIGINAL EQUIVALENT REF. N°
NP	19.013	30	BioHorizons® 130-050
NP	19.312	30	
RP/WP	19.014	30	BioHorizons® 140-050
RP/WP	19.328	35	

INT HEX MI

FITS
MIS® SEVEN



NP	19.056	30	
NP	19.656	30	MIS® MN-S0160
SP/WP	19.081	30	MIS® MD-S0220
SP/WP	19.681	30	
SP/WP AURUMBase®	19.417	30	
Multi-unit® MIS®	19.085	25	
Multi-unit® MIS®	19.685	25	MIS® MU-S0220

CONIC MC

FITS
MIS® C1



NP	19.056	30	
NP	19.656	30	MIS® MN-S0160
SP/WP	19.081	30	MIS® MD-S0220
SP/WP	19.681	30	
Multi-unit® MIS®	19.085	25	
Multi-unit® MIS®	19.685	25	MIS® MU-S0220

CONIC MV

FITS
MIS® V3



NP	19.056	30	
NP	19.656	30	MIS® MN-S0160
SP	19.081	30	MIS® MD-S0220
SP	19.681	30	
Multi-unit® MIS®	19.085	25	
Multi-unit® MIS®	19.685	25	MIS® MU-S0220

CONIC ANYR

FITS
MEGAGEN AnyRidge®



All platforms	19.057	35	
All platforms	19.657	35	Megagen® AANMSF
All platforms AURUMBase®	19.460	35	

CONIC AXIO

FITS
ANTHOGYR AXIOM®



On implant	19.077	25	Anthogyr® OPTS161
On implant	19.677	25	
Multi-unit® abutment	19.062	15	
Multi-unit® abutment	19.662	15	

CONIC IC

FITS
MEDENTIS ICX®



PLATFORM SIZE	DESS REF. N°	DESS RECOMMENDED TORQUE (Ncm)	ORIGINAL EQUIVALENT REF. N°
On implant	19.080	30	Medentis® C-007-000001-01
On implant	19.680	30	
On implant AURUMBase® H2.2	19.444	30	
On implant AURUMBase® H0.9	19.443	30	

CONIC INK

FITS
GLOBALD IN-KONE®



On implant	19.086	15	GlobalD® DVPCI
On implant	19.686	15	
Conical abutment Straight	19.035	15	GlobalD® DVPIINK
Conical abutment Straight	19.635	15	
Conical abutment angled	19.036	15	
Conical abutment angled	19.636	15	

CONIC DENT

FITS
DENTIUM SUPERLINE™ & IMPLANTIUM®



On implant	19.090	30	Dentium® ASC 2045
On implant	19.690	30	
On abutment	19.066	10	Dentium® SRS 18T
On abutment	19.666	10	

INTERNAL SEM

FITS
BEGO Semados®



On implant	19.091	30	Bego® 57.031
On implant	19.691	30	

CONIC BIO

FITS
BIOTECH KONTAKT®



On implant	19.078	20	Biotech® KVP
On implant	19.678	20	
Conical abutment Narrow	19.063	20	
Conical abutment Narrow	19.663	20	
Conical abutment Standard	19.064	20	Biotech® KECGMV
Conical abutment Standard	19.664	20	

INTERNAL BT

FITS
BT1®



On implant	19.079	35	
On implant	19.679	35	
Multi IM®	19.065	10	
Multi IM®	19.665	10	

All DESS products are manufactured according to ISO 9001:2015 and ISO 13485:2016 with CE marking for all products Class IIb

All DESS® AURUMBase® screws and screwdrivers are based on the standard ISO 10664

3i® and 3i Certain®, Miniplant®, MicroMiniplant™ and Osseofite® are registered trademarks of 3i Implant Innovations, USA

ASTRA TECH™, OsseoSpeed™, ANKYLOS® C/X, XiVE®, FRIADENT®, ASTRATECH implant system™ EV and UniAbutment®

are registered trademarks of DENTSPLY SIRONA Implants

BioHorizons® is a registered trademark of BioHorizons, INC.

Brånemark System®, NobelReplace® and Replace Select™, NobelActive™, NobelReplace® CC, NobelSpeedy™ and Multi-unit® are

registered trademarks of Nobel Biocare AB, Sweden

ITI®, Straumann® and synOcta® are registered trademarks of Straumann Holding AG, Switzerland

MIS® is a registered trademark of MIS Implant Technologies Ltd.

Zimmer Screw-Vent® and SwissPlus® are registered trademarks of Zimmer Dental INC, USA

Dyna® is a registered trademark of Dyna Dental Engineering BV

Locator® is a registered trademark of ZEST IP Holdings

Camlog® and Conelog® are registered trademarks of CAMLOG Biotechnologies AG

Megagen® is a registered trademark of MEGAGEN IMPLANT CO. LTD

TORX® is a trademark of ACUMENT INTELLECTUAL PROPERTIES, LLC

Bego Semados® is a registered trademark of BEGO GmbH & Co. KG

Anthogyr® is a registered trademark of Anthogyr SAS

Medentis ICX® is a registered trademark of medentis medical GmbH

Osstem® is a registered trademark of OSSTEM IMPLANT CO. LTD

Dentium® is a trademark of Dentium Co. Ltd.

GOBALD® is a trademark of Global D SASU.

Biotech Kontakt® is a trademark Biotech Dental SAS.

BTI® is a trademark BTI Biotechnology Institute.

DESS products can be used only by licensed dentists, physicians and labs.

Please refer ever to the instructions of use available on the website

www.dess-abutments.com

or supplied with the product.

Some products may not be available in your country. Some of the products are cleared for US and Canada.

Please contact your local distributor for more details.



DOC-16-ENG-04



DESS

> DENTAL SMART SOLUTIONS

www.dess-abutments.com